



Kits e Reparos de Caixa e Bomba de
Direção Hidráulica
versão 2016

RioPreto
Distribuidora de Vedações

Índice

Kit Ferramenta Especial	04
Agrale	05
Alfa Romeo	05
Asia Motors	05
Audi	06
BMW	06
Chery	07
Chevrolet	07
Chrysler	10
Citroën	10
Daewoo - Saab	11
Dodge	11
Fiat	12
Ford	13
Honda	16
Hyundai	17
Iveco	18
Jeep	19
Kia	19
Land Rover	20
Lexus	20
Mazda	20
Mercedes	21
Mitsubishi	23
Nissan	24
Peugeot	24
Renault	25
Scania	26
Subaru	27
Suzuki	27
Toyota	28
Troller	29
Volkswagen	29
Volvo	31
Problemas x Causas	55

Kit Ferramenta Especial



CX.33000 - TRW/DHB - Kit Ferramenta Especial para Montagem - Direção Hidráulica - Linha Leve

Praticidade para o aplicador, segurança e bem-estar para o usuário

Medidas da Maleta: 24 x 40 x 9cm (Sujeito a disponibilidade de estoque. Consulte o depto. de vendas)

Cód. AGEL	Ref. Mercado	Aplicação	Coifas	Buchas	Página
CX.22001	ZF.7863.698.001	Rep. BBA. Agrale Volare 7500 / 8500 / FN4			46
CX.22032	ZF.7673.698.032	Rep. BBA. Agrale Netuno 4T / Puma			46
CX.33255	ZF.8090.698.255	Rep. CX. Agrale 7000 / 7500 / 8500 / Volare A6 / A8 / Puma 914			46

Alfa Romeo

Cód. AGEL	Ref. Mercado	Aplicação	Coifas	Buchas	Página
CX.22005	ZF.7681.698.258	Rep. BBA Alfa Romeo 164 (Cód. Bomba 7681.955.253)			46
CX.33040	TRW	Rep. CX. Alfa Romeo Spider (96 a 00) / GTV (95 a 97)	X	X	46
CX.33040/2	TRW	Rep. CX. Alfa Romeo Spider (96 a 00) / GTV (95 a 97)		X	46
CX.33042	TRW	Rep. CX. Alfa Romeo 145 / 146 (94 a 99)	X	X	46
CX.33042/2	TRW	Rep. CX. Alfa Romeo 145 / 146 (94 a 99)		X	46
CX.33751/2	TRW	Rep. CX. Alfa Romeo 164		X	46

Asia Motors

Cód. AGEL	Ref. Mercado	Aplicação	Coifas	Buchas	Página
CX.22300	KIO	Rep. BBA. Asia Topic (Retentor 20mm)			39
CX.33019	JAPAN	Rep. CX. Asia Topic (Vedação da Gaxeta NPSK-ORPU-0050)	X		46
CX.33116	TRW	Rep. CX. Asia Topic após 94	X		46
CX.33116/2	TRW	Rep. CX. Asia Topic após 94			46

Audi

Cód. AGEL	Ref. Mercado	Aplicação	Coifas	Buchas	Página
CX.22004	ZF	Rep. BBA. Audi A6/A6 Quattro (92 a 97) / A8 / A8 Quattro (97 a 98)			46
CX.22700	ZF. 7681.633.003	Rep. BBA. Audi			32
CX.33006	ZF. 7881.955.319	Rep. CX. Audi A80 (86 a 94) / A90 (93 a 95) / Audi S2 (ZF. 7881.955.313)	X	X	46
CX.33010	ZF	Rep. CX. Audi TT após 98 (Cremalheira 24MM.)	X		32
CX.33010/2	ZF	Rep. CX. Audi TT após 98 (Cremalheira 24MM.)			32
CX.33014/2	ZF. 7852.974.336	Rep. CX. Audi A4-1.6 / 1.8 / 1.8T / Quattro 95			32
CX.33016/2	ZF. 7847.991.533	Rep. CX. Audi 100 / 200 / 5000 (1992) / A6		X	32
CX.33035/2	ZF	Rep. CX. Audi 80 / 90 - 100 (90 a 94) (Cód. Caixa 7847.955.238/244) Rep. CX. Audi A6 (94 a 98) / Audi 5000 (Cód. Caixa 7847.955.229)			32
CX.33078/2	ZF.7852.993.108/110	Rep. CX. Audi A8			46
CX.33086/2	ZF	Rep. CX. Audi A6 (Cód. Caixa 7852.993.172/210/211/232/233)			46
CX.33087/2	ZF. 7852.993.178	Rep. CX. Audi A6			46
CX.33096	ZF. 7852.974.393/489	Rep. CX. Audi A4			32
CX.33098	ZF. 7852.991.151	Rep. CX. Audi A8 (Cód. Caixa 7852.991.151/152/160)			46
CX.33099	ZF. 7852.993.145	Rep. CX. Audi A6			47
CX.33953	ZF. 7891.633.501	Rep. CX. Audi A3 após 98	X	X	33
CX.33953/2	ZF. 7891.633.501	Rep. CX. Audi A3 após 98		X	33
CX.33954/2	KOYO / SMI	Rep. CX. Audi A4 (94 A 00)			47

BMW (+)

Cód. AGEL	Ref. Mercado	Aplicação	Coifas	Buchas	Página
CX.22015	LUK.LH - 1.137.951	Rep. BBA. BMW Série 300 / 500			33
CX.22051	KYB / ZF	Rep. BBA. BMW Série 300 (Eixo 15MM.) (99 a 02)			47
CX.22958	ZF	Rep. BBA. BMW Série 300 / 500 / 700 após 88			33
CX.33008/2	ZF. 7852.955.229	Rep. CX. BMW Série 3 (92 a 95)			33
CX.33009/2	ZF	Rep. CX. BMW Série 5 após 96 (c/ ou s/ Servotronic 28MM.)			33
CX.33011	ZF. 7852.955.227/306	Rep. CX. BMW Série (E36) com coifas	X		33
CX.33011/2	ZF. 7852.955.227/306	Rep. CX. BMW Série (E36) sem coifas			33

(+) BMW

Cód. AGEL	Ref. Mercado	Aplicação	Coifas	Buchas	Página
CX.33018	ZF.8052.955.172	Rep. CX. BMW S-540 (1980...) ST FIM.			47
CX.33025/2	TRW	Rep. CX. BMW Z-3 (96 a 01) / 323 (00) (Cremalheira 28MM.)			33
CX.33076/2	ZF. 7852.993.419/760	Rep. CX. BMW X5			47
CX.33077/2	ZF	Rep. CX. BMW 745i (E65) (Cód. Caixa 7852.993.229/269/402/403/536)			47
CX.33088/2	ZF	Rep. CX. BMW X5 (Cód. Caixa 7852.974.553/554/560/561/775/880)			47
CX.33091	ZF. 7852.993.167	Rep. CX. BMW 526i / 528i / 540i			47
CX.33092	ZF. 7852.955.223/224	Rep. CX. BMW			33
CX.33093	ZF. 7852.955.278	Rep. CX. BMW 526 / 528 / 540			47
CX.33094/2	ZF.7852.974.490 /981/678/712	Rep. CX. BMW 320 / 325 / 330 / 328			33
CX.33096	ZF. 7852.974.393/489	Rep. CX. BMW			32
CX.33097	ZF. 7852.991.157/149	Rep. CX. BMW 528i			33

Chery

Cód. AGEL	Ref. Mercado	Aplicação	Coifas	Buchas	Página
CX.33127		Rep. CX. Tiggo STL com coifas	X		47
CX.33127/2		Rep. CX. Tiggo STL sem coifas			47

Chevrolet (+)

Cód. AGEL	Ref. Mercado	Aplicação	Coifas	Buchas	Página
CX.22001	ZF. 7683.698.001	Rep. BBA. Silverado / D40 Maxion FN4			46
CX.22003	BOMBA TC 17MM.	Rep. BBA. Corvette (97 a 03) / Lumina (Motor 3.1)			33
CX.22021	BOMBA KYB	Rep. BBA. Captiva 08...			47
CX.22022	ZF. 7673.698.022	Rep. BBA. (ZF 125) A-C40			33
CX.22023	ZF. 7673.698.023	Rep. BBA. (ZF 908) D-20 / ACD 10 / Bonanza			33
CX.22028	ZF. 7673.698.028	Rep. BBA. Opala / ACD 10 / Veraneio / Bonanza / Caravan (Caneco)			33
CX.22077	DHB 1.804.077	Rep. BBA. Monza / Kadet até 89			34

(+) Chevrolet (+)

Cód. AGEL	Ref. Mercado	Aplicação	Coifas	Buchas	Página
CX.22090	LUK	Rep. BBA. Blazer / S-10 após 00 (Bomba acoplada com bomba vácuo)			34
CX.22103	BOMBA TC 19MM.	Rep. BBA. Omega 3.0 / Suprema (93 a 98)			34
CX.22107	SAGINAW	Rep. BBA. C10 / C14 / D20 (Bomba com reservatório acoplado) Rep. BBA. S10 / Blazer (Motor V6) (Reservatório acoplado)			34
CX.22176	ZF. 7672.698.176	Rep. BBA. Opala / Caravan / ACD 10 após 85			34
CX.22249	ZF. 7691.698.001	Rep. BBA. S-10 / Blazer 95... / Omega / Suprema (93 a 98)			34
CX.22304	DHB 1.804.304	Rep. BBA. Montana Pickup 03... / Corsa / Pickup / Wagon 94... Rep. BBA. Monza / Kadet / Ipanema 90... / Lumina 3.8L 92 a 94			34
CX.22305	DHB 1804.305	Rep. BBA. S-10 / Ranger / Sprinter DHB Reversa			47
CX.22800	ZF. 7683.298.800	Rep. BBA. Silverado MWM			34
CX.33012	SAGINAW	Rep. CX. Corvette (84 a 96)	X	X	34
CX.33012/2	SAGINAW	Rep. CX. Corvette (84 a 96)		X	34
CX.33013/2	ZF. 7836.974.160/193	Rep. CX. Astra / Calibra / Vectra (94 a 96)			34
CX.33015	ZF. 8053.698.015	Rep. CX. Opala / Caravan / ACD10 / D20 / Veraneio / Bonanza (74 a 84)			35
CX.33031	SAGINAW / DHB	Rep. CX. Lumina (Van 90 a 99) / Lumina (Automóvel 94 a 03)	X	X	34
CX.33049	DHB 1.804.049	Rep. CX. Astra s/ ar após 99	X	X	34
CX.33049/2	DHB 1.804.049	Rep. CX. Astra s/ ar após 99		X	34
CX.33062/2	DHB 1.804.062	Rep. CX. Monza / Kadet até 90			35
CX.33070	TRW	Rep. CX. Astra após 99... (com bomba elétrica)	X	X	35
CX.33070/2	TRW	Rep. CX. Astra após 99... (com bomba elétrica)		X	35
CX.33071	TRW	Rep. CX. Zafira após 01... (com bomba elétrica)	X	X	35
CX.33071/2	TRW	Rep. CX. Zafira após 01... (com bomba elétrica)		X	35
CX.33089	SAGINAW / DHB	Rep. CX. Blazer / S10 (95 a 98) / (Setor 32MM) c/ Junta			35
CX.33090	SAGINAW / DHB	Rep. CX. Blazer / Suburban / S10 após 99 (Setor 35,50MM.) C/ Junta			36
CX.33100	DHB 1.804.100	Rep. CX. Monza / Ipanema / Kadet 90... / Astra / Calibra / Vectra(94 a 96)	X		35
CX.33100/2	DHB 1.804.100	Rep. CX. Monza / Ipanema / Kadet 90... / Astra / Calibra / Vectra(94 a 96)			35
CX.33101	ZF. 8053.698.013	Rep. Sem Fim C10 / D20 / D40			35
CX.33107	ZF. 7891.633.002	Rep. CX. Vectra (Opel 97 a 05) com coifas	X	X	35
CX.33107/2	ZF. 7891.633.002	Rep. CX. Vectra (Opel 97 a 05) sem coifas		X	35

(+) Chevrolet

Cód. AGEL	Ref. Mercado	Aplicação	Coifas	Buchas	Página
CX.33108	SAGINAW / DHB	Rep. CX. Blazer / S10 (Setor 32 e 35,5MM.) c/ Junta			36
CX.33112	KOYO / BENDIX	Rep. CX. Space-Van (Ret. Cremalheira com aba)	X		35
CX.33112/2	KOYO / BENDIX	Rep. CX. Space-Van (Ret. Cremalheira com aba)			35
CX.33122	DHB 1.804.122	Rep. CX. D11000 a 22000 após 83 (2 Pistões)			34
CX.33130	DHB 1.804.130	Rep. CX. D20 / D40 / A20 / C10 / Silverado Nac. após 85 c/ junta			35
CX.33140	SMI / KOYO	Rep. CX. Space-Van (Ret. Cremalheira sem aba)	X		43
CX.33140/2	SMI / KOYO	Rep. CX. Space-Van (Ret. Cremalheira sem aba)			43
CX.33143	DHB 1.804.143	Rep. CX. Vectra (96 a 05) / Zafira após 02	X	X	35
CX.33143/2	DHB 1.804.143	Rep. CX. Vectra (96 a 05) / Zafira após 02		X	35
CX.33166	Rep.Cx.Agile após 10	Rep. CX. Prisma / Celta / Agile após 10... com coifas	X	X	45
CX.33166/2	Rep.Cx.Agile após 10	Rep. CX. Prisma / Celta / Agile após 10... sem coifas		X	45
CX.33167	Rep. Cx. Captiva	Rep. CX. Captiva Bucha Reta após 08... Retentor 48mm com coifas	X	X	45
CX.33167/2	Rep. Cx. Captiva	Rep. CX. Captiva Bucha Reta após 08... Retentor 48mm sem coifas		X	45
CX.33168	Rep. Cx. Captiva	Rep. CX. Captiva Bucha Cônica após 08... com coifas	X	X	45
CX.33168/2	Rep. Cx. Captiva	Rep. CX. Captiva Bucha Cônica após 08... sem coifas		X	45
CX.33169	DHB 1.804.169	Rep. CX. Corsa (94 a 02) / Tigra (94 a 01) / Celta após 00	X	X	34
CX.33169/2	DHB 1.804.169	Rep. CX. Corsa (94 a 02) / Tigra (94 a 01) / Celta após 00		X	34
CX.33171/2	KYB	Rep. CX. KYB Omega Fittipaldi 2007...			47
CX.33179	ZF. 8053.698.179	Rep. CX. Opala / Caravan (85 a 90)			35
CX.33186	DHB 1.804.186	Rep. CX. Astra após 02 / Vectra após 05	X	X	37
CX.33186/2	DHB 1.804.186	Rep. CX. Astra após 02 / Vectra após 05		X	37
CX.33210	ZF. 8053.698.210	Rep. CX. D20 / D40 / Bonanza / Veraneio / A-10 (85 a 90)			35
CX.33235	ZF. 8053.698.235	Rep. CX. Opala / Silverado / Veraneio / D20 / Bonanza após 90 (Servotronic)			35
CX.33251	ZF. 8052.698.251	Rep. CX. Omega / Suprema (93 a 98)			35
CX.33252/2	TRW	Rep. CX. Omega Australiano após 99		X	47
CX.33827	DHB 1.804.485/486	Rep. CX. Corsa / Meriva / Montana após 02	X	X	34
CX.33827/2	DHB 1.804.485/486	Rep. CX. Corsa / Meriva / Montana após 02		X	34
CX.33828	DHB 1.804.486	Rep. CX. Corsa / Meriva / Montana 06... coifa com respiro	X	X	47
CX.33828/2	DHB 1.804.486	Rep. CX. Corsa / Meriva / Montana 06... sem coifa		X	47

Chrysler

Cód. AGEL	Ref. Mercado	Aplicação	Coifas	Buchas	Página
CX.22054	ZF	Rep. BBA. Chrysler Caravan / Grand Caravan (90 a 91) / Town & Country Rep. BBA. Chrysler Caravan ES (88 a 91) / Lebaron / GTS (88 a 91) Rep. BBA. Chrysler Limousine (88 a 91) / Maserati (88 a 91)			36
CX.22107	SAGINAW	Rep. BBA. Chrysler Caravan / Gran Caravan (85 a 98)			34
CX.22932	KOYO	Rep. BBA. Chrysler Neon (97 a 00)			48
CX.33145/2	CX. TRW	Rep. PT Cruiser 02 a 06 sem coifa			48
CX.33147/2	TRW	Rep. CX. Chrysler Caravan / Grand Caravan (96 a 98) / Neon (95 a 01)			36
CX.33148/2	CX. TRW	Rep. CX. Stratus / Neon / 95 a 98 / Caravan 96 a 98 sem coifa			48
CX.33247/2	Cruiser CX. Imp.	Rep. Neon após 00... CX. Importada PT Cruiser 02 a 03			48

Citroën (+)

Cód. AGEL	Ref. Mercado	Aplicação	Coifas	Buchas	Página
CX.22001	ZF. 7863.698.001	Rep. BBA. Citroën Jumper após 01			46
CX.22003	BOMBA TC 17MM.	Rep. BBA. Citroën Berlingo / Xsara / Picasso após 96 / ZX após 94			33
CX.22049	ZF	Rep. BBA. Citroën ZX após 94 (Eixo 19MM.)			48
CX.22054	ZF	Rep. BBA. Citroën Evasion (95 a 00)			36
CX.22103	BOMBA TC 19MM.	Rep. BBA. Citroën Berlingo / Xsara / Picasso após 96 / ZX após 94			34
CX.22802	ZF. 7683.298.802	Rep. BBA. Citroën Jumper (Cód. BBA. 7683.955.114/911/926)			36
CX.33150	TRW	Rep. Válvula Citroën Berlingo / Xantia / Saxo após 96 Rep. Válvula Citroën Xsara / Picasso após 99 / ZX após 94	X		36
CX.33152	ZF	Rep. Válvula Citroën ZX (95 a 98) (Coifas iguais)	X		44
CX.33153	ZF	Rep. Válvula Citroën Picasso / Xsara após 99 (Ret.Inf.Ext. 43 e 47MM.) Rep. Válvula Citroën Berlingo após 96 / Xantia (Ret.Inf.Ext. 43 e 47MM.) Rep. Válvula Citroën ZX / XM após 94 (Ret.Inf.Ext. 43 e 47MM.)	X		36
CX.33156	TRW	Rep. CX. Citroën Synergie (94 a 02) / Citroën Evasion (94 a 02)	X		36
CX.33156/2	TRW	Rep. CX. Citroën Synergie (94 a 02) / Citroën Evasion (94 a 02)			36

(+) Citroën

Cód. AGEL	Ref. Mercado	Aplicação	Coifas	Buchas	Página
CX.33157	ZF.Z8-X4	Rep. CX. Citroën C5 (01 A 07) (Cód. Caixa Z8-X4)	X		48
CX.33940	TRW	Rep. CX. Jumper	X		37
CX.33940/2	TRW	Rep. CX. Jumper		X	37

Daewoo - Saab

Cód. AGEL	Ref. Mercado	Aplicação	Coifas	Buchas	Página
CX.33013/2	ZF. 7536.633.007	Rep. CX. Saab 900 (93 a 98)			34
CX.33031	SAGINAW / DHB	Rep. CX. Daewoo Nubira	X		34
CX.33100/2	DHB 1.804.100	Rep. CX. Daewoo Espero Rep. CX. Saab 900 (93 a 98) / Saab (98 a 02)			35

Dodge

Cód. AGEL	Ref. Mercado	Aplicação	Coifas	Buchas	Página
CX.22054	ZF	Rep. BBA. Dodge Aries / Daytona (88 a 89) / Dynasty (90 a 91)			36
CX.22101	HDB / KOYO	Rep. BBA. Dodge Ram 1500/2500/3500 (Reservatório acoplado do lado)			36
CX.22107	SAGINAW	Rep. BBA. Dodge Dakota (97 a 03) Exceto 4.7L			34
CX.33050	FORD Importado	Rep. CX. Dodge Ram 1500/2500/3500 (03 a 08) (Setor 35MM.)			36
CX.33085	DHB	Rep. CX. Dodge Ram 1500/2500/3500 (94 a 98)			36
CX.33147/2	TRW	Rep. CX. Dodge Caravan / Mini Ram (96 a 98)			36
CX.33149/2	TRW	Rep. CX. Aries / Daytona / Lancer (81 a 95) / Dynasty (88 a 93)			36

Fiat (+)

Cód. AGEL	Ref. Mercado	Aplicação	Coifas	Buchas	Página
CX.22001	ZF. 7683.698.001	Rep. BBA. Fiat Ducato (Alumínio)			46
CX.22023	ZF. 7673.698.023	Rep. BBA. (ZF 908) 190 - 190H			33
CX.22103	BOMBA TC 19MM	Rep. BBA. Tempra / Tempra SW (93 a 98) / Tipo 94 a 96			34
CX.22249	ZF. 7691.698.249	Rep. BBA. Tipo (94 a 96) / Tempra (93 a 98)			34
CX.22304	DHB 1.804.304	Rep. BBA. Prêmio / Elba / Uno / Fiorino / Tempra			34
CX.22602	ZF. 8695.633.003	Rep. BBA. ZF. Ducato Nova 12...			48
CX.22802	ZF. 7683.298.802	Rep. BBA. Fiat Ducato			36
CX.33017	ZF. 8065.698.017	Rep. CX. 190 e 190H / 619 / 697 / Villares			37
CX.33109	TRW ITALIANA	Rep. CX. Fiat Marea / Marea Weekend / Brava (95 a 02) / Tempra SW	X	X	36
CX.33109/2	TRW ITALIANA	Rep. CX. Fiat Marea / Marea Weekend / Brava (95 a 02) / Tempra SW		X	36
CX.33110	TRW 37.502.239	Rep. CX. Tipo 2.0 (94 a 96) / Tempra SW (93 a 98) Italiana Serial nº37502239	X	X	36
CX.33110/2	TRW 37.502.239	Rep. CX. Tipo 2.0 (94 a 96) / Tempra SW (93 a 98) Italiana Serial nº37502239		X	36
CX.33111	TRW 37.502.253	Rep. CX. Tipo 1.6 (94 a 98) Italiana Serial nº 37502253	X	X	37
CX.33111/2	TRW 37.502.253	Rep. CX. Tipo 1.6 (94 a 98) Italiana Serial nº 37502253		X	37
CX.33199	DHB. 1.804.199	Rep. CX. Tempra / Elba / Uno / Prêmio após 94	X	X	37
CX.33199/2	DHB. 1.804.199	Rep. CX. Tempra / Elba / Uno / Prêmio após 94		X	37
CX.33736	TRW.16.150.736	Rep. CX. Palio / Palio Weekend (96 a 01 antiga)	X	X	37
CX.33736/2	TRW.16.150.736	Rep. CX. Palio / Palio Weekend (96 a 01 antiga)		X	37
CX.33758	TRW 16.150.758	Rep. CX. Tempra / Elba / Prêmio / Uno...94	X	X	37
CX.33758/2	TRW 16.150.758	Rep. CX. Tempra / Elba / Prêmio / Uno...94		X	37
CX.33760	TRW 16.150.760	Rep. CX. Tempra / Uno após 95	X	X	37
CX.33760/2	TRW 16.150.760	Rep. CX. Tempra / Uno após 95		X	37
CX.33844	TRW 16.150.844	Rep. CX. Palio / Doblò / Idea / Strada / Siena após 01 (Motor Fire)	X	X	37
CX.33844/2	TRW 16.150.844	Rep. CX. Palio / Doblò / Idea / Strada / Siena após 01 (Motor Fire)		X	37
CX.33845	TRW 51783036	Rep. CX. Punto 08... Serial nº 51783036	X	X	48
CX.33845/2	TRW 51783036	Rep. CX. Punto 08... Serial nº 51783036		X	48
CX.33847	JTEKT	Rep. CX. Palio / Siena / Uno 2008... com coifas	X	X	48
CX.33847/2	JTEKT	Rep. CX. Palio / Siena / Uno 2008... sem coifas		X	48

(+) Fiat

Cód. AGEL	Ref. Mercado	Aplicação	Coifas	Buchas	Página
CX.33940	TRW	Rep. CX. Ducato após 95	X	X	37
CX.33940/2	TRW	Rep. CX. Ducato após 95		X	37
CX.33943	TRW	Rep. CX. Ducato após 2010 (Caixa Blindada)	X		43
CX.33943/2	TRW	Rep. CX. Ducato após 2010 (Caixa Blindada)			43

Ford (+)

Cód. AGEL	Ref. Mercado	Aplicação	Coifas	Buchas	Página
CX.22001	ZF. 7683.698.001	Rep. BBA. F 12000 / 14000 / Cargo / 814 / B1618 (FN 4)			46
CX.22022	ZF. 7673.698.022	Rep. BBA. (ZF 125) F1000 a F4000 até 89			33
CX.22029	ZF. 7673.698.029	Rep. BBA. F7000 a F22000 até 89			37
CX.22052	FORD	Rep. BBA. Focus após 00			48
CX.22054	ZF	Rep. BBA. Maverick após 93 / Scorpio (86 a 89)			36
CX.22059	REP. BBA. FUSION	Rep. BBA. Fusion 08... com reservatório acoplado			48
CX.22100	FORD	Rep. BBA. Aerostar (86 a 97) / Excursion (Diesel 7.3L - 00 a 02) Rep. BBA. Expedition (Diesel 7.3L - 97 a 02) / Explorer Gasolina 93... Rep. BBA. F250 (97 a 97) / Landau / Galaxie / Taurus 3.0L 12V (92 a 00) Rep. BBA. Windstar (95 a 98) / Ranger Gasolina após 93			37
CX.22101	HBD / KOYO	Rep. BBA. Courier 98... / Escort / Verona 97... Rep. BBA. Fiesta / KA / Mondeo (92 a 02)			36
CX.22103	BOMBA TC 19MM.	Rep. BBA. Explorer / Ranger após 93 Diesel			34
CX.22176	ZF. 7672.698.176	Rep. BBA. F1000 a F4000 após 90			34
CX.22194	ZF. 7671.698.194	Rep. BBA. Del Rey / Belina / Pampa / Scala (84 a 96) Rep. BBA. Versailles / Royale (92 a 96)			37
CX.22207	ZF. 7674.698.207	Rep. BBA. Cargo - 16170/16210			37
CX.22249	ZF. 7691.698.249	Rep. BBA. Escort / Verona			34
CX.22304	DHB 1.804.304	Rep. BBA. F1000 a F4000 / Ecosport / Fiesta			34

Cód. AGEL	Ref. Mercado	Aplicação	Coifas	Buchas	Página
CX.22800	ZF. 7683.298.800	Rep. BBA. F250 / 350 / 1000 MWM			34
CX.22801	ZF. 7683.298.801	Rep. BBA. F250 / 350 / 1000 CUMMINS			37
CX.33017	ZF. 8065.298.017	Rep. CX. Servocom ZF			37
CX.33030	ZF. 8058.698.030	Rep. CX. F7000 a F8500			38
CX.33050	FORD	Rep. CX. F250 após 97 / F350 após 97 (Setor 35MM.)			36
CX.33055	ZF. 8053.698.055	Rep. CX. F1000 a F4000 até 89			38
CX.33060	ZF. 8058.698.031	Rep. Sem Fim F7000 a F8500			38
CX.33075	FORD	Rep. CX. Ecosport / Fiesta / Amazon após 03 (Bucha + Êmbolo)	X	X	38
CX.33075/2	FORD	Rep. CX. Ecosport / Fiesta / Amazon após 03 (Bucha + Êmbolo)		X	38
CX.33095	ZF. 7852.633.021	Rep. CX. Ford (Importada) (Cód. Caixa 7852.991.123/124/130)			38
CX.33101	ZF. 8053.698.013	Rep. Sem Fim F1000 a F4000 / F19000			35
CX.33102	BENDIX	Rep. CX. Ford Cargo			39
CX.33103	TRINTER	Rep. CX. Escort / Verona 92...	X	X	39
CX.33103/2	TRINTER	Rep. CX. Escort / Verona 92...		X	39
CX.33104	FORD	Rep. CX. Fiesta / Courier 98... / Mondeo (92 a 02) / KA 96...	X	X	39
CX.33104/2	FORD	Rep. CX. Fiesta / Courier 98... / Mondeo (92 a 02) / KA 96...		X	39
CX.33119	TRW	Rep. CX. Ford Focus 02...	X	X	39
CX.33119/2	TRW	Rep. CX. Ford Focus 02...		X	39
CX.33121	TRINTER	Rep. CX. Escort 97... (Motor Zetec)	X	X	39
CX.33121/2	TRINTER	Rep. CX. Escort 97... (Motor Zetec)		X	39
CX.33151/2	FORD	Rep. CX. Mustang (86 a 88) e (96 a 02)			38
CX.33163	FORD-7E51-3200-A	Rep. CX. Fusion (06 a 09) K052X, (AE-78C6098) com coifas	X		45
CX.33163/2	FORD-7E51-3200-A	Rep. CX. Fusion (06 a 09) K052X, (AE-78C6098) sem coifas			45
CX.33164	FOMOCO	Rep. CX. Focus 2011... TENDRIVE.GCYB > AL-SI9CU3	X	X	48
CX.33164/2	FOMOCO	Rep. CX. Focus 2011... TENDRIVE.GCYB > AL-SI9CU3		X	48
CX.33165	FORD	Rep. CX. Taurus (86 a 95) e (90 a 92) Com e Sem Assistência Variável	X		38
CX.33165/2	FORD	Rep. CX. Taurus (86 a 95) e (90 a 92) Com e Sem Assistência Variável			38
CX.33200	TRINTER	Rep. CX. Ford Focus Trinter 02... com coifas	X	X	39

Cód. AGEL	Ref. Mercado	Aplicação	Coifas	Buchas	Página
CX.33200/2	TRINTER	Rep. CX. Ford Focus Trinter 02...		X	39
CX.33206	ZF. 7832.698.206	Rep. CX. Del Rey / Belina / Pampa / Scala (84 a 96) com coifas	X		38
CX.33206/2	ZF. 7832.698.206	Rep. CX. Del Rey / Belina / Pampa / Scala (84 a 96) sem coifas			38
CX.33210	ZF. 8053.698.210	Rep. CX. F1000 a F4000			35
CX.33218	ZF. 8053.698.218	Rep. CX. F1000			38
CX.33220/2	FORD	Rep. CX. Ford Taurus (00 a 02) / Windstar (01 a 03)			39
CX.33221/2	FORD	Rep. CX. Ford Windstar (95 a 97)			39
CX.33222	VISTEON	Rep. CX. Ford Focus (00 a 05) com coifas	X		45
CX.33222/2	VISTEON	Rep. CX. Ford Focus (00 a 05) sem coifas			45
CX.33223	FORD TRANSIT	Rep. CX. Ford Transit 08... com coifas	X		48
CX.33223/2	FORD TRANSIT	Rep. CX. Ford Transit 08... sem coifas			48
CX.33226	ZF. 8097.698.226	Rep. CX. Cargo 1717 a 5031 (Tampas de Plástico)			37
CX.33230	ZF. 8095.698.230	Rep. CX. Servocom F11000 a 14000 (Tampas laterais de plástico)			38
CX.33231	ZF. 8095.298.808	Rep. CX. Servocom F11000 a 14000 (Tampas laterais de borracha)			38
CX.33238	ZF. 7881.698.238	Rep. CX. Versailles / Royale 92..	X		38
CX.33238/2	ZF. 7881.698.238	Rep. CX. Versailles / Royale 92..			38
CX.33318	FORD CX. TRW	Rep. CX. Fiesta EcoSport / KA 2010... com coifas Cx. TRW	X	X	49
CX.33318/2	FORD CX. TRW	Rep. CX. Fiesta EcoSport / KA 2010... sem coifas Cx. TRW		X	49
CX.33750	TRW. 16.150.750	Rep. CX. Escort / Verona 93 a 96	X	X	39
CX.33750/2	TRW. 16.150.750	Rep. CX. Escort / Verona 93 a 96		X	39
CX.33754	TRW. 16.150.754	Rep. CX. Versailles / Royale 92...	X		38
CX.33754/2	TRW. 16.150.754	Rep. CX. Versailles / Royale 92...			38
CX.33764	TRW. 22.150.764	Rep. CX. F1000 a F4000 (92 a 98) / F250 / F350 após 97 (TAS-20)			39
CX.33771	TRW. 16.150.771	Rep. CX. Ford 814 (TAS-30)			38
CX.33775	TRW. 22.150.775	Rep. CX. Cargo 1215 a 1422 (TAS-65) com junta			39
CX.33775/3	TRW. 22.150.775	Rep. CX. Cargo 1215 a 1422 (TAS-65) sem junta			39
CX.33810	ZF. 8097.298.810	Rep. CX. Cargo 1717 a 5031 (Tampas de Borracha)			38
CX.33907	ZF	Rep. CX. Escort após 92 com coifas	X	X	48

(+) Ford

Cód. AGEL	Ref. Mercado	Aplicação	Coifas	Buchas	Página
CX.33907/2	ZF	Rep. CX. Escort após 92 sem coifas		X	48
CX.33914	FORD	Rep. CX. Ranger 98 a 03... / Explorer 95 (Conexão rosca)	X	X	39
CX.33914/2	FORD	Rep. CX. Ranger 98 a 03... / Explorer 95 (Conexão rosca)		X	39
CX.33915	FORD	Rep. CX. Ranger após 01 (Conexão engate rápido)	X	X	45
CX.33915/2	FORD	Rep. CX. Ranger após 01 (Conexão engate rápido)		X	45
CX.33916	FORD VISTEON	Rep. CX. Ranger Pinhão e Cremalheira (Com Rosca / Plug Com Coifas)	X	X	48
CX.33916/2	FORD VISTEON	Rep. CX. Ranger Pinhão e Cremalheira (Com Rosca / Plug)		X	48
CX.33917	FORD	Rep. CX. FOMOCO - Ranger 2013... com coifas	X		49
CX.33917/2	FORD	Rep. CX. FOMOCO - Ranger 2013...			49
CX.33924	FORD	Rep. CX. Ranger (94 a 97) / Explorer (91 a 94) (Setor 33MM.)			39

(+) Honda

Cód. AGEL	Ref. Mercado	Aplicação	Coifas	Buchas	Página
CX.33852/2	KOYO	Rep. CX. Honda Accord (98 a 03) 04Cil.			49
CX.33853/2	KOYO	Rep. CX. Honda Accord (94 a 97) 04 Cil.			49
CX.33854/2	KOYO	Rep. CX. Honda Accord (98 a 02) 06 Cil.			49
CX.33855/2	SHOWA	Rep. CX. Honda CR-V 07...			49
CX.33856	TRW	Rep. CX. Honda Civic (96 a 99) (Bucha Longa 54MM)	X	X	49
CX.33856/2	TRW	Rep. CX. Honda Civic (96 a 99) (Bucha Longa 54MM)		X	49
CX.33857	TRW	Rep. CX. Accord 4 Cil. 06 a 07 / CRV 98 a 01 / New Civic após 06... com coifas	X		49
CX.33857/2	TRW	Rep. CX. Accord 4 Cil. 06 a 07 / CRV 98 a 01 / New Civic após 06...			49

Honda (+)

Cód. AGEL	Ref. Mercado	Aplicação	Coifas	Buchas	Página
CX.22057	BBA Importada	Rep. BBA. New Civic 2006... (Legacy)			49
CX.22058	BBA Importada	Rep. BBA. Civic / CRV- Accord 4cc 01 A 02 (Legacy)			49
CX.22080	KOYO	Rep. BBA. Honda Civic (96 a 00) / Accord(98 a 02) Exceto V6 Odyssey 98			33
CX.33834/2	KOYO	Rep. CX. Honda Civic (96 a 00)			49
CX.33835/2	SHOWA	Rep. CX. Honda Civic (01 a 06)			49
CX.33849	SHOWA	Rep. CX. Honda Civic (92 a 95) (Com Gaxetas) Rep. CX. Honda Del Sol (93 a 95) Exceto V-Tec (Com Gaxetas)	X		36
CX.33849/2	SHOWA	Rep. CX. Honda Civic (92 a 95) (Com Gaxetas) Rep. CX. Honda Del Sol (93 a 95) Exceto V-Tec (Com Gaxetas)			36
CX.33850	TRW	Rep. CX. Honda Civic (96 a 99) (Bucha Curta 42MM.)	X	X	39
CX.33850/2	TRW	Rep. CX. Honda Civic (96 a 99) (Bucha Curta 42MM.)		X	39
CX.33851	SHOWA	Rep. CX. Honda New Civic após 06 (Exceto SI) com coifa	X	X	49
CX.33851/2	SHOWA	Rep. CX. Honda New Civic após 06 (Exceto SI)		X	49

Hyundai (+)

Cód. AGEL	Ref. Mercado	Aplicação	Coifas	Buchas	Página
CX.22055	Importado	Rep. BBA. Azera 2010... (importado)			49
CX.22056	Importado	Rep. BBA. Santa Fé 2011... (importado)			49
CX.22300	YOUNG SHIN	Rep. BBA. Hyundai HR após 07			39
CX.22940	KOYO	Rep. BBA. Hyundai Tucson após 05			50
CX.33500/2	KOYO	Rep. CX. Hyundai H1			50
CX.33501/2	KOYO	Rep. CX. Hyundai Trajet			50
CX.33502	MANDO 577002B000	Rep. CX. Santa Fé 01 a 06			50
CX.33502/2	MANDO 577002B000	Rep. CX. Hyundai Santa Fé 01 a 06			50
CX.33503	MANDO 577002B210	Rep. CX. Hyundai Santa Fé após 07... c/ coifa	X	X	45
CX.33503/2	MANDO 577002B210	Rep. CX. Hyundai Santa Fé após 07... s/ coifa		X	45
CX.33504	MANDO	Rep. CX. Hyundai HR após 07	X	X	45
CX.33504/2	MANDO	Rep. CX. Hyundai HR após 07		X	45
CX.33506/2	KOYO	Rep. CX. Hyundai Elantra (96 a 00)			50
CX.33507/2	KOYO / TRW	Rep. CX. Hyundai H100			50
CX.33508/2	KOYO	Rep. CX. Hyundai Excel (86 a 96)			50

(+) Hyundai

Cód. AGEL	Ref. Mercado	Aplicação	Coifas	Buchas	Página
CX.33510/2	MANDO	Rep. CX. Hyundai H100			50
CX.33511/2	MANDO	Rep. CX. Hyundai Azera após 08...			50
CX.33512	MANDO	Rep. CX. Hyundai Tucson após 06... com coifas KNC. 577001f800	X	X	45
CX.33512/2	MANDO	Rep. CX. Hyundai Tucson após 06...		X	45
CX.33513	MANDO	Rep. CX. Mando Hyundai IX 35 2013... com coifas	X	X	50
CX.33513/2	MANDO	Rep. CX. Mando Hyundai IX 35 2013... sem coifas		X	50

Jeep

Cód. AGEL	Ref. Mercado	Aplicação	Coifas	Buchas	Página
CX.22003	BOMBA TC 17MM	Rep. BBA. Jeep Grand Cherokee (96 a 98) / Wrangler (97 a 99) Rep. BBA. Jeep Cherokee / Comanche / Wagoneer (96 a 98)			33
CX.22107	SAGINAW	Rep. BBA. Cherokee / Comanche / Wrangler (Reservatório acoplado)			34
CX.33089	SAGINAW	Rep. CX. Jeep Cherokee / Comanche / Wagoneer (93 a 95) Rep. CX. Jeep Grand Cherokee (93 a 95) / Jeep Wrangler (93 a 96)			35
CX.33090	DHB / SAGINAW	Rep. CX. Jeep Grand Cherokee (96 a 98) / Jeep Wrangler (97 a 01)			36
CX.33146	TRW	Rep. CX. Jeep Cherokee / Jeep Crysler / Jeep Wrangler			40

Iveco

Cód. AGEL	Ref. Mercado	Aplicação	Coifas	Buchas	Página
CX.22001	ZF. 7683.698.001	Rep. BBA. Iveco Turbo Daily / 150 e 20 N/T e 160 e 23 N/T FN4			46
CX.22020	ZF. 8695.955.116	Rep. BBA. Iveco Eurocargo / Stralis (Cód. BBA. 8695.955.116)			50
CX.33230	ZF. 8095.698.230	Rep. CX. Iveco Eurocargo (Tampas laterais de plástico)			38
CX.33231	ZF. 8095.298.808	Rep. CX. Iveco Eurocargo (Tampas laterais de borracha)			38
CX.33810	ZF. 8097.298.810	Rep. CX. Iveco Eurotrakker / Eurocargo (Tampas laterais de borracha) Rep. CX. Iveco Stralis / 140 / 190 (Tampas laterais de borracha)			38
CX.33811	ZF. 8098.298.800	Rep. CX. Iveco Expression / CC170 E22 Iribus			40
CX.33940	TRW	Rep. CX. Iveco Turbo Daily	X	X	37
CX.33940/2	TRW	Rep. CX. Iveco Turbo Daily		X	37
CX.33943	TRW	Rep. CX. Iveco Turbo Daily 55C16-2010... (Caixa Blindada)	X		43
CX.33943/2	TRW	Rep. CX. Iveco Turbo Daily 55C16-2010... (Caixa Blindada)			43

Kia

Cód. AGEL	Ref. Mercado	Aplicação	Coifas	Buchas	Página
CX.22300	KIO	Rep. BBA. Grand Besta (Ret. 20MM.)			39
CX.22940	KOYO	Rep. BBA. Kia Sportage 05...			50
CX.33072	TRW	Rep. CX. Kia Carnival...07	X		40
CX.33072/2	TRW	Rep. CX. Kia Carnival...07			40
CX.33116	TRW	Rep. CX. Kia Besta / Bongo K-2700	X		46
CX.33116/2	TRW	Rep. CX. Kia Besta / Bongo K-2700			46
CX.33512	MANDO	Rep. CX. Kia Sportage (05 a 06) com coifas	X	X	45
CX.33512/2	MANDO	Rep. CX. Kia Sportage (05 a 06)		X	45
CX.33938	KIA	Rep. CX. Kia Sportage (05 a 06)			40

Land Rover

Cód. AGEL	Ref. Mercado	Aplicação	Coifas	Buchas	Página
CX.22051	KYB / ZF	Rep. BBA. Land Rover/Range Rover 4.6 Gas. Após 99 (Eixo 15MM)			47
CX.33901	INGLATERRA	Rep. CX. Land Rover Defender (04 Fixações) após 93			50
CX.33902	INGLATERRA	Rep. CX. Land Rover Defender / Range Rover (03 Fixações) após 93			50
CX.33903	INGLATERRA	Rep. CX. Land Rover Defender (04 + 02 Fixações) após 93			50
CX.33904	INGLATERRA	Rep. CX. Land Rover / Range Rover (91 a 02) Série I (STC2847) Rep. CX. Range Rover (91 a 02) Série I (STC2847)			45
CX.33905	ZF. 8055.633.022	Rep. CX. Range Rover			40

Lexus

Cód. AGEL	Ref. Mercado	Aplicação	Coifas	Buchas	Página
CX.33241	KOYO	Rep. CX. Lexus ES300 com coifas	X		50
CX.33241/2	KOYO	Rep. CX. Lexus ES300			50

Mazda

Cód. AGEL	Ref. Mercado	Aplicação	Coifas	Buchas	Página
CX.22100	FORD	Rep. BBA. Mazda B2300 (94 a 97) / B2500 (98 a 99) / Protégé 01 Rep. BBA. Mazda B3000 / B4000 (94 a 99) / Navajo (91 a 95)			37
CX.33182/2	TRW	Rep. CX. Mazda MPV Van 4 x 2 / 4 x 4 (89 a 95)			40
CX.33183	TRW	Rep. CX. Mazda 626 (93 a 99) / MX-6 (93 a 97)	X		40
CX.33183/2	TRW	Rep. CX. Mazda 626 (93 a 99) / MX-6 (93 a 97)			40
CX.33924	FORD	Rep. CX. Mazda Navajo (91 a 94) (Setor 33MM.)			39

Mercedes (+)

Cód. AGEL	Ref. Mercado	Aplicação	Coifas	Buchas	Página
CX.22001	ZF. 7683.698.001	Rep. BBA. 1938S / OM449LA / OM447LA / O-400 (Motor BR-400) FN4 Rep. BBA. SLK (Motor BR-450) / Ônibus O-400 (Motor BR-450) FN4 Rep. BBA. L98 (Motor BR-900) / LS 1632 ano 98 / 2325 ano 99 FN4			46
CX.22002	ZF. 7683.698.002	Rep. BBA. 1620 / 1623 / 1720 FN3			40
CX.22005	ZF. 7681.698.258	Rep. BBA. MB 180			46
CX.22022	ZF. 7673.698.022	Rep. BBA. (ZF 125) - 1113 a 2213			33
CX.22023	ZF. 7673.698.023	Rep. BBA. (ZF 908) - 1519 / 1520 - 1924 a 1934			33
CX.22030	ZF. 7673.698.030	Rep. BBA. FPN / HPN Ônibus OF 1618 / 1620			40
CX.22090	LUK	Rep. BBA. Sprinter (Bomba acoplada com bomba vácuo)			34
CX.22105	BOSCH	Rep. BBA. Bosch Ret. 25 x 40 x 08			40
CX.22167	MBB. 000466167	Rep. Reservatório (Só Borracha)			40
CX.22208	ZF. 7673.955.545	Rep. BBA. Mercedes (1418) Novo			44
CX.22249	ZF. 7691.698.249	Rep. BBA. Sprinter			34
CX.22263	ZF. 7673.698.263	Rep. BBA. 1214 / 1218 / 1414 - 1418 / 1714 / 2418			40
CX.22811	ZF. 7673.298.801	Rep. BBA. Mercedes 1618 / 1935 (Cód. BBA. 7673.955.534/545/711)			40
CX.33002	ZF. 8065.698.002	Rep. CX. 1924 / 1929 / 1932 / 1933 / 1934			41
CX.33005	TRW. 22.150.404	Rep. Árvore de Entrada (HFB 64) Ônibus OF/OH 1115 / 1315 / 1318			40
CX.33007	ZF. 8062.698.007	Rep. CX. 1113 a 2213 (Antiga)			41
CX.33017	ZF. 8065.698.017	Rep. CX. 1935 a 1941 - 0370 - 0371			37
CX.33030	ZF. 8058.698.030	Rep. CX. 709 / 912 / 809 / 812 / 914			38
CX.33052	DAIMER CHRYSLER	Rep. CX. Mercedes 1620 (LS6 BK)			51
CX.33053	DAIMER CHRYSLER	Rep. CX. Mercedes 1933 Axor (LS8 BK)			51
CX.33060	ZF. 8058.698.031	Rep. Sem Fim 709 / 912 / 809 / 812 / 914			38
CX.33061	ZF. 8063.698.173	Rep. Sem Fim (8062 / 8063)			41
CX.33080	ZF	Rep. CX. Mercedes 200 / 230 / 250 / 280 / 300 / 320 / 350 Rep. CX. Mercedes Classe C - C250 / C280 até 97 (Pistão 68 mm.)			41

(+) Mercedes

Cód. AGEL	Ref. Mercado	Aplicação	Coifas	Buchas	Página
CX.33081	ZF	Rep. CX. Mercedes 200 / 220 / 230 / 240 / 250 / 280 (Pistão 86MM)			41
CX.33082/2	ZF	Rep. CX. Mercedes Classe M após 97...			41
CX.33083/2	ZF	Rep. CX. Mercedes Classe E			41
CX.33084/2	ZF	Rep. CX. Mercedes ML320 / ML430 (98 a 01)			51
CX.33170	ZF. 8063.698.170	Rep. CX. 1113 a 2218 (Moderna)			41
CX.33180	TRW	Rep. CX. MB 180 (TAS-15)			41
CX.33226	ZF. 8097.698.226	Rep. CX. Servocom - 1614 a 1620 (Tampas de plástico)			37
CX.33230	ZF. 8095.698.230	Rep. CX. Servocom - 1218 a 2214 (Tampas laterais de plástico)			38
CX.33231	ZF. 8095.298.808	Rep. CX. Servocom - 1218 a 2214 (Tampas laterais de borracha)			38
CX.33255	ZF. 8090.698.255	Rep. CX. L0914 / L709 / L912 / L98 / 712C / 914C			46
CX.33261	ZF. 8063.698.261	Rep. CX. Ônibus 370/12			41
CX.33610	MBB. 9014610401	Rep. CX. Sprinter (97 a 07) Sem Fim Fino	X	X	41
CX.33610/2	MBB. 9014610401	Rep. CX. Sprinter (97 a 07) Sem Fim Fino		X	41
CX.33611	MBB. 9014611401	Rep. CX. Sprinter (97 a 07) Sem Fim Grosso	X	X	41
CX.33611/2	MBB. 9014611401	Rep. CX. Sprinter (97 a 07) Sem Fim Grosso		X	41
CX.33612	MBB	Rep. CX. Sprinter (97 a 07) Sem Fim Fino/Grosso	X	X	41
CX.33612/2	MBB	Rep. CX. Sprinter (97 a 07) Sem Fim Fino/Grosso		X	41
CX.33800	ZF. 8065.298.800	Rep. CX. 1935 / 2635 / 1938 / 1941 (Troleibus)			41
CX.33810	ZF. 8097.298.810	Rep. CX. Servocom (Todos 8097) (Tampas de borracha)			38
CX.33811	ZF. 8098.298.800	Rep. CX. Servocom - OF 1732 / 2836GL / GLE / 0-500 M/R/U			40
		Rep. CX. Servocom - Axor 1933S a 2828S			
		Rep. CX. Servocom 3340K / 3340S / 3344K / 3344S			
CX.33865	TRW	Rep. CX. Mercedes Classe A (98 a 05) com coifas	X	X	51
CX.33865/2	TRW	Rep. CX. Mercedes Classe A (98 a 05)		X	51
CX.33900	TRW. 22.150.783/787	Rep. CX. Ônibus / Caminhão OF/OH 1115 / 1315 / 1318 (HFB 64) i5990			41

Mitsubishi

Cód. AGEL	Ref. Mercado	Aplicação	Coifas	Buchas	Página
CX.22009	KOYO	Rep. BBA. Mitsubishi 3000 GT (90 a 94) / Mirage (93 a 94)			51
CX.22010	KOYO	Rep. BBA. Mitsubishi 3000 GT (95 a 98) / Diamante (95 a 02)			42
		Rep. BBA. Mitsubishi Galant (90 a 92) / Mirage (96 a 98)			
		Rep. BBA. Mitsubishi Pajero (92 a 98) / Eclipse (91 a 93)			
CX.22300	KIO	Rep. BBA. Mitsubishi L200 após 95 (Ret. 20MM)			39
CX.22931	KOYO	Rep. BBA. Mitsubishi L200 / L300 após 94			42
CX.22933	KOYO	Rep. BBA. Mitsubishi Eclipse (94 a 99)			51
CX.33128/2	TRW	Rep. CX. Outlander Airtrek 03/05 sem Coifas			51
CX.33160/2	KOYO	Rep. CX. Mitsubishi Space Wagon / Cordia / Tredia (84 a 87)			42
CX.33921	KOYO	Rep. CX. L200 (92 a 03) (Setor 30MM.)			51
CX.33930/2	KOYO	Rep. CX. Mitsubishi Space Wagon / Expo (92 a 97)			51
CX.33931	KOYO	Rep. CX. Mitsubishi L200 (92 a 03) (Setor 32MM)			42
CX.33933	KOYO	Rep. CX. Mitsubishi L200 Sport / L200 GLS após 03 (Setor 35MM)			42
CX.33934	KOYO	Rep. CX. Mitsubishi Pajero Full após 02... com coifas	X	X	51
CX.33934/2	KOYO	Rep. CX. Mitsubishi Pajero Full após 02...		X	51
CX.33935	MANDO	Rep. CX. Mitsubishi Pajero / Pajero Sport (94 a 01) / Montero			40
CX.33936/2	MANDO	Rep. CX. Mitsubishi L300(Ret.Cremalheira 27,7x46x13 + 27,7x42x12,50)			51
CX.33937	KOYO	Rep. CX. Mitsubishi L200 Triton 08... com coifas (Cremalheira 32MM)	X		51
CX.33937/2	KOYO	Rep. CX. Mitsubishi L200 Triton 08... (Cremalheira 32MM)			51
CX.33939/2	KOYO / TRW	Rep. CX. Mitsubishi Eclipse (95 a 99) / Galant (93 a 96)			51
CX.33941/2	KOYO	Rep. CX. Mitsubishi Eclipse (05 a 06) / Galant (03 a 04)			51
CX.33942/2	KOYO	Rep. CX. Mitsubishi Pajero TR4 após 02 / 10 (99 a 02)		X	51
CX.33944	KOYO	Rep. CX. Koyo S/Fim - Mitsubishi L-200 92 a 03 Setor 30 e 32MM			52

Nissan

Cód. AGEL	Ref. Mercado	Aplicação	Coifas	Buchas	Página
CX.22090	LUK	Rep. BBA. Frontier após 01 (Bomba acoplada com bomba vácuo)			34
CX.33246/2	KOYO	Rep. CX. Nissan Frontier após 05... (Retentor 32x53)			32
CX.33926/2	TRW	Rep. CX. Nissan Saloon Ex / Super após 93 Rep. CX. Nissan Sentra 99 a 06 / 200 SX 95 a 98			42
CX.33929	DELPHI	Rep. CX. Nissan Frontier 02... / X-Terra 04...			42
CX.33945	KOYO	Rep. CX. Frontier 2010... N° 8124025/ S. CO LTD com coifas	X		52
CX.33945/2	KOYO	Rep. CX. Frontier 2010... N° 8124025/ S. CO LTD			52
CX.33967/2	KOYO	Rep. CX. Nissan Pathfinder (95 a 04) V6 - 3.5L			52
CX.33968	KOYO	Rep. CX. Nissan Pathfinder ... 95 / X-Terra 01...			42

Peugeot (+)

Cód. AGEL	Ref. Mercado	Aplicação	Coifas	Buchas	Página
CX.22001	ZF. 7683.698.001	Rep. BBA. Peugeot Boxer			46
CX.22304	DHB. 1.804.304	Rep. BBA. Peugeot 206 após 02 / 307 após 01 / 405 SRI (92 a 98)			34
CX.22936	KOYO	Rep. BBA. Peugeot 206 - 1.0 e 1.6 / 307 após 01 (Com Junta)			52
CX.33115	TRW	Rep. CX. Peugeot 206 / 307 (Válvula TRW + Carcaça T1 ou T5)	X	X	42
CX.33115/2	TRW	Rep. CX. Peugeot 206 / 307 (Válvula TRW + Carcaça T1 ou T5)		X	42
CX.33120	ZF	Rep. Válvula Peugeot 405 / 605	X		42
CX.33150	TRW	Rep. Válvula Peugeot 106 / 306 após 96	X		36
CX.33153	ZF	Rep. Válvula Peugeot Partner (Ret. Inf. Ext. 43 e 47MM)	X		36
CX.33156	TRW	Rep. CX. Peugeot 806 / Expert (94 a 02)	X		36
CX.33156/2	TRW	Rep. CX. Peugeot 806 / Expert (94 a 02)			36
CX.33172	ZF	Rep. CX. Peugeot 206 / 307 / (Válvula ZF + Carcaça T5)	X	X	42
CX.33172/2	ZF	Rep. CX. Peugeot 206 / 307 / (Válvula ZF + Carcaça T5)		X	42
CX.33173	REP. CX.206MIX	Rep. CX. Peugeot 206 MIX com coifas	X	X	45
CX.33173/2	REP. CX.206MIX	Rep. CX. Peugeot 206 MIX sem coifas		X	45

(+) Peugeot

Cód. AGEL	Ref. Mercado	Aplicação	Coifas	Buchas	Página
CX.33175/2	ZF	Rep. CX. Peugeot 406 (Carcaça D9)			42
CX.33940	TRW	Rep. CX. Peugeot Boxer (94 a 02)	X	X	37
CX.33940/2	TRW	Rep. CX. Peugeot Boxer (94 a 02)		X	37

Renault (+)

Cód. AGEL	Ref. Mercado	Aplicação	Coifas	Buchas	Página
CX.22001	ZF. 7683.698.001	Rep. BBA. Renault Master			46
CX.22107	SAGINAW	Rep. BBA. Renault Megane (Reservatório Acoplado)			34
CX.22304	DHB. 1.804.304	Rep. BBA. Clio / Kangoo / Megane / Scenic após 2002			34
CX.22802	ZF. 7683.298.802	Rep. BBA. Renault Master (Cód. BBA. 7683.955.114/911/926)			36
CX.22936	IMPORTADA	Rep. BBA. Clio - 1.0 e 1.6 (Com Junta)			52
CX.33112	KOYO / BENDIX	Rep. CX. Renault Trafic (Retentores com abas)	X		35
CX.33112/2	KOYO / BENDIX	Rep. CX. Renault Trafic (Retentores com abas)			35
CX.33117	KOYO - 7740000015	Rep. CX. Renault Scenic / Megane após 98...	X	X	42
CX.33117/2	KOYO - 7740000015	Rep. CX. Renault Scenic / Megane após 98...		X	42
CX.33118	KOYO - 771/7720000004	Rep. CX. Renault Clio 1.0 e 1.6 / Kangoo após 99 / Symbol após 10...	X		42
CX.33118/2	KOYO - 771/7720000004	Rep. CX. Renault Clio 1.0 e 1.6 / Kangoo após 99 / Symbol após 10...			42
CX.33123	KOYO	Rep. CX. Renault Symbol 2010...	X		52
CX.33123/2	KOYO	Rep. CX. Renault Symbol 2010...			52
CX.33124	JTEKT	Rep. CX. Renault Sandero / Logan 2013...	X	X	52
CX.33124/2	JTEKT	Rep. CX. Renault Sandero / Logan 2013...		X	52
CX.33125	SMI / RENAULT	Rep. CX. Renault Clio 94 a 98 / 19 (93 a 99) (Cremalheira 25MM)	X		42
CX.33125/2	SMI / RENAULT	Rep. CX. Renault Clio 94 a 98 / 19 (93 a 99) (Cremalheira 25MM)			42
CX.33126	ZF	Rep. CX. Renault 19 / Renault 21 / Nevada (93 a 99)	X		43
CX.33126/2	ZF	Rep. CX. Renault 19 / Renault 21 / Nevada (93 a 99)			43
CX.33137	TRW	Rep. CX. Renault Scenic / Megane até 99	X	X	43

(+) Renault

Cód. AGEL	Ref. Mercado	Aplicação	Coifas	Buchas	Página
CX.33137/2	TRW	Rep. CX. Renault Scenic / Megane até 99		X	43
CX.33140	KOYO/SMI	Rep. CX. Trafic (Retentores sem abas)	X		43
CX.33140/2	KOYO/SMI	Rep. CX. Trafic (Retentores com abas)			43
CX.33142/2	MASTER KOYO	Rep. CX. Renault Master (03 a 08) (Ret. Carcaça Ext. 45 e 46MM)		X	45
CX.33144/2	MASTER JEKT	Rep. CX. JETKT KOYO após 10...			45
CX.33176	KOYO	Rep. CX. Laguna	X		52
CX.33176/2	KOYO	Rep. CX. Laguna			52
CX.33279/2	TRW	Rep. CX. Duster após 13...		X	45
CX.33846	TRW	Rep. CX. Logan / Sandero após 07...	X	X	52
CX.33846/2	TRW	Rep. CX. Logan / Sandero após 07...		X	52

Scania (+)

Cód. AGEL	Ref. Mercado	Aplicação	Coifas	Buchas	Página
CX.22001	ZF. 7683.698.001	Rep. BBA. P / R / T 94 / 114 / 124 FN4			46
CX.22034	ZF. 7677.698.034	Rep. BBA. LT111 / T112 - B - L - LS			43
CX.22035	ZF. 7677.698.035	Rep. BBA. R124 - 143 - LK140 - 141			43
CX.22104	LUK-543.0035.10	Rep. BBA. LUK 112 / 113 / 114 / 124			43
CX.22801	ZF. 7683.298.801	Rep. BBA. Scania (Motor Cummins)			37
CX.33002	ZF. 8065.698.002	Rep. CX. BR110 / 115 - 116			41
CX.33017	ZF. 8065.698.017	Rep. CX. BR111			37
CX.33067	ZF. 8044.955.119	Rep. CX. 112 Sueca (Cód. Caixa 8044.955.119)			52
CX.33068	ZF. 8044.698.068	Rep. CX. R-K-T 112/113 - 142/143			43
CX.33141	UNIVERSAL	Rep. CX. Universal Trafic com coifas	X		52
CX.33141/2	UNIVERSAL	Rep. CX. Universal Trafic sem coifas			52
CX.33226	ZF. 8097.698.226	Rep. CX. Servocom R113 / L113 / S113 / Ônibus (Tampas de Plástico)			37
CX.33779	TRW. 22.150.779/837	Rep. CX. R-T-K113 / 124 / 143 (TAS-85301) / 114 / 124 (TAS85303/304) c/ junta			43

(+) Scania

Cód. AGEL	Ref. Mercado	Aplicação	Coifas	Buchas	Página
CX.33779/3	TRW. 22.150.779/837	Rep. CX. R-T-K113 / 124 / 143 (TAS-85301) / 114 / 124 (TAS 85303/304) s/ junta			43
CX.33791	TRW. 22.150.791	Rep. CX. R-T 112 a 143 / K112 / 112TL (HFB-70) com junta			43
CX.33791/3	TRW. 22.150.791	Rep. CX. R-T 112 a 143 / K112 / 112TL (HFB-70) sem junta			43
CX.33810	ZF. 8097.298.810	Rep. CX. Servocom R113 / L113 / S113 / Ônibus (Tampas de Plástico)			38
CX.33811	ZF. 8098.298.800	Rep. CX. Scania Ônibus Exportação (8098)			40

Subaru

Cód. AGEL	Ref. Mercado	Aplicação	Coifas	Buchas	Página
CX.33044	TRW	Rep. CX. Subaru Legacy (00 a 03) (Cremalheira 25MM)	X	X	43
CX.33044/2	TRW	Rep. CX. Subaru Legacy (00 a 03) (Cremalheira 25MM)		X	43
CX.33045/2	KOYO	Rep. CX. Subaru Legacy (90 a 98) (2 Retentores Cremalheira 24x38,5MM)			52
CX.33046/2	KOYO	Rep. CX. Subaru Legacy (00 a 01) / Impreza após 93 (Retentor Cremalheira 24x35 + 24x38,5MM)			52
CX.33047/2	KOYO	Rep. CX. Subaru Legacy (05 a 07) (2 Retentores Cremalheira 24x42MM)			52
CX.33048/2	KOYO	Rep. CX. Subaru Impreza (04 a 06) (Retentor Cremalheira 24x41 + 24x36,5 MM)			52
CX.33059/2	KOYO	Rep. CX. Subaru Forester (05 a 07) (Cremalheira 23MM)			52

Suzuki

Cód. AGEL	Ref. Mercado	Aplicação	Coifas	Buchas	Página
CX.22012	KOYO	Rep. BBA. Suzuki Swift (95 a 97)			53
CX.22930	KOYO	Rep. BBA. Suzuki Vitara (96 a 98)			54
CX.22941	KOYO	Rep. BBA. Suzuki Vitara (89 a 95)			32
CX.33320/2	KOYO	Rep. CX. Gran Vitara 98 a 03 / Tracker GM 2008... Cremalheira			54
CX.33932	KOYO SAMURAI	Rep. CX. Suzuki Sidekick (96 a 98) 1.6 / Vitara (Setor 28MM) até 97			43

Toyota

Cód. AGEL	Ref. Mercado	Aplicação	Coifas	Buchas	Página
CX.22011	KOYO	Rep. BBA. Hilux (91 a 04) (Bomba com Polia)			53
CX.22600	IMPORTADO	Rep. BBA. Toyota Bandeirantes (Motor Importado)			43
CX.22601	KOYO	Rep. BBA. Hilux após 05 (Bomba de Engrenagem - Ferro)			53
CX.22603	REP. IMPOR. ALUMI	Rep. BBA. Hilux Alumi com Engrenagem Pit Bull			53
CX.22933	KOYO	Rep. BBA. Toyota Hilux Gasolina (96 a 99) / Landcruiser 98 a 02 / Camry			51
CX.22934	KOYO	Rep. BBA. Toyota Previa (90 a 97)			53
CX.22936	KOYO	Rep. BBA. Toyota Corolla (97 a 02) / Paseo (96 a 97) (Com junta)			52
CX.22938	KOYO	Rep. BBA. Toyota RAV4 (96 a 00) / Celica (94 a 95) / Hilux Gasolina			53
CX.33113	TOYOTA	Rep. CX. Toyota Hilux SW4 / SR5 / SRV (91 a 95) (Setor 36MM)			43
CX.33114	TOYOTA	Rep. CX. Toyota Hilux SW4 (96 a 04) (Cremalheira 35MM)	X		44
CX.33114/2	TOYOTA	Rep. CX. Toyota Hilux SW4 (96 A 04) (Cremalheira 35MM)			44
CX.33214	KOYO PIT BULL	Rep. CX. Toyota Hilux SR5 / SW4 após 05 com coifas	X		45
CX.33214/2	KOYO	Rep. CX. Toyota Hilux SR5 / SW4 após 05			45
CX.33215	KOYO	Rep. CX. Toyota Hilux SR5 / SRV (Setor 32MM)			44
CX.33218	ZF. 8053.698.218	Rep. CX. Toyota Bandeirantes			38
CX.33232	KOYO	Rep. CX. Toyota Corolla / Matrix (02 a 07) com coifas	X		53
CX.33232/2	KOYO	Rep. CX. Toyota Corolla / Matrix (02 a 07)			53
CX.33236	KOYO	Rep. CX. Toyota Corolla (93 a 01) Caixa Bi-Partida com coifa	X		53
CX.33236/2	KOYO	Rep. CX. Toyota Corolla (93 a 01) Caixa Bi-Partida			53
CX.33237	KOYO	Rep. CX. Toyota Corolla (96 a 01) / RAV4 (96 a 03) Cx. Inteiriça c/ coifa	X		53
CX.33237/2	KOYO	Rep. CX. Toyota Corolla (96 a 01) / RAV4 (96 a 03) Caixa Inteiriça			53
CX.33239	CX. ZF	Rep. CX. Toyota Corona (96 a 00) CX. ZF	X		53
CX.33239/2	CX. ZF	Rep. CX. Toyota Corona (96 a 00) CX. ZF			53
CX.33240/2	KOYO	Rep. CX. Toyota Camry (02 a 06)			53
CX.33242/2	KOYO	Rep. CX. Toyota Camry (91 a 01) / Avalon (00 a 04)			53
CX.33243/2	KOYO	Rep. CX. Toyota Camry 07...			53
CX.33244/2	KOYO	Rep. CX. Toyota Paseo (93 a 97)			53
CX.33245/2	KOYO	Rep. CX. Toyota RAV4 (04 a 05) (Cremalheira 25,5MM)			53

Troller

Cód. AGEL	Ref. Mercado	Aplicação	Coifas	Buchas	Página
CX.33210	ZF. 8053.698.210	Rep. CX. Troller T4			35
CX.33251	ZF. 8052.698.251	Rep. CX. Troller T4			35

Volkswagen (+)

Cód. AGEL	Ref. Mercado	Aplicação	Coifas	Buchas	Página
CX.22001	ZF. 7683.698.001	Rep. BBA. 12.140 / 16.170 / Ônibus 16-180 / VW 7/8T FN4			46
CX.22002	ZF. 7683.698.002	Rep. BBA. LT7 / 8T FN3			40
CX.22003	BOMBA TC 17MM	Rep. BBA. Bora 98... / Golf 99... / New Beetle 98...			33
CX.22022	ZF. 7673.698.022	Rep. BBA. E21 / 1400 DT - Caminhões até 83			33
CX.22032	ZF. 7673.698.032	Rep. BBA. 26.170 / 13.130 / 7.110S / 7.90S			46
CX.22044	ZF. 7672.698.044	Rep. BBA. 11.130 / 13.130 - Caminhões até 83			44
CX.22050	ZF. 7612.298.800	Rep. BBA. Polo / Fox após 2003 (ZF / KYB)			54
CX.22053	ZF. KYB Importada	Rep. BBA. ZF/KYB Space Fox G5 / após 10... Importado			54
CX.22103	BOMBA TC 19MM	Rep. BBA. Golf / Passat / Variant (95 a 98) / Polo (97 a 98)			34
CX.22176	ZF. 7672.698.176	Rep. BBA. 11.130 / 13.130 Caminhões após 84			34
CX.22194	ZF. 7671.698.194	Rep. BBA. Santana / Quantum			37
CX.22207	ZF. 7674.698.207	Rep. BBA. 13.210 / 15.210			37
CX.22208	ZF. 7673.698.208	Rep. BBA. 13.130 / 14.200 - 7.90 / 7.110			44
CX.22249	ZF. 7691.698.249	Rep. BBA. Golf (95 a 98) / Santana / Quantum 93... Rep. BBA. Logus / Pointer / (93 a 96) / Passat / Variant (Alemão 95 a 98)			34
CX.22304	DHB. 1.804.304	Rep. BBA. Gol / Parati / Voyage / Saveiro / Apolo 90 a 92 Rep. BBA. Logus / Pointer 93 a 96 / Santana / Quantum 96 a 98			34
CX.22800	ZF. 7683.298.800	Rep. BBA. MWM 4.07			34
CX.33014/2	ZF. 7852.633.026	Rep. CX. Passat / Variant 98...			32
CX.33020/2	ZF. 7852.633.014	Rep. CX. Eurovan / Caravelle			44
CX.33030	ZF. 8058.698.030	Rep. CX. 11.130 / 13.130 - 13.210 / 14.210			38
CX.33033	DHB. 1.804.033	Rep. CX. Gol / Parati / Saveiro após 95...	X		44

(+) Volkswagen (+)

Cód. AGEL	Ref. Mercado	Aplicação	Coifas	Buchas	Página
CX.33033/2	DHB. 1.804.033	Rep. CX. Gol / Parati / Saveiro após 95...			44
CX.33060	ZF. 8058.698.031	Rep. Sem Fim 11.130 / 13.130 - 13.210 / 14.210			38
CX.33101	ZF. 8053.698.013	Rep. Sem Fim 11.130 / 13.130			35
CX.33105	TRINTER	Rep. CX. Gol / Parati / Saveiro / Voyage após 95	X	X	44
CX.33105/2	TRINTER	Rep. CX. Gol / Parati / Saveiro / Voyage após 95		X	44
CX.33106	TRW. ITALIANA	Rep. CX. Golf Antiga / Variant (95 a 98) Alemão/Van (Furgão 98...)	X		43
CX.33106/2	TRW. ITALIANA	Rep. CX. Golf Antiga / Variant (95 a 98) Alemão/Van (Furgão 98...)			43
CX.33195	ZF. 7881.698.195	Rep. CX. Santana / Quantum (85 a 91)	X		44
CX.33195/2	ZF. 7881.698.195	Rep. CX. Santana / Quantum (85 a 91)			44
CX.33224	ZF	Rep. CX. Golf / Passat / Variant 95 a 98 com coifas	X		54
CX.33224/2	ZF	Rep. CX. Golf / Passat / Variant 95 a 98			54
CX.33225	DHB. 1.804.225	Rep. CX. Gol / Parati / Saveiro até 94 (Válvula Alumínio)	X		44
CX.33225/2	DHB. 1.804.225	Rep. CX. Gol / Parati / Saveiro até 94 (Válvula Alumínio)			44
CX.33226	ZF. 8097.698.226	Rep. CX. Servocom - 16.170 a 40.430 (Tampas de Plástico) Rep. CX. Constellation 17.260 a 31.360 (Tampas de Plástico)			37
CX.33238	ZF. 7881.698.238	Rep. CX. Santana / Quantum (91 a 96)	X		38
CX.33238/2	ZF. 7881.698.238	Rep. CX. Santana / Quantum (91 a 96)			38
CX.33248	KOYO SMI	Rep. CX. Passat Alemão após 00 (08281253)	X		54
CX.33248/2	KOYO SMI	Rep. CX. Passat Alemão após 00 (0828125) 8DI422072			54
CX.33255	ZF. 8090.698.255	Rep. CX. 8-140 CO / 8-150 OD / 9-150 OD			46
CX.33319	REP CX. TRW	Gol G5 / Voyage após 09... com coifas	X	X	54
CX.33319/2	REP CX. TRW	Gol G5 / Voyage após 09... sem coifas		X	54
CX.33750	TRW. 16.150.750	Rep. CX. Logus / Pointer (93 a 96)	X	X	39
CX.33750/2	TRW. 16.150.750	Rep. CX. Logus / Pointer (93 a 96)		X	39
CX.33752	TRW. 16.150.752	Rep. CX. Gol / Parati / Saveiro / Voyage após 95	X		44
CX.33752/2	TRW. 16.150.752	Rep. CX. Gol / Parati / Saveiro / Voyage após 95			44
CX.33754	TRW. 16.150.754	Rep. CX. Santana / Quantum após 93	X		38
CX.33754/2	TRW. 16.150.754	Rep. CX. Santana / Quantum após 93			38

(+) Volkswagen

Cód. AGEL	Ref. Mercado	Aplicação	Coifas	Buchas	Página
CX.33771	TRW. 22.150.771	Rep. CX. 7100 a 8140 - TAS-30305 - (TAS-30)			38
CX.33775	TRW. 22.150.775	Rep. CX. 11.140 a 14.170 (TAS-65) com junta			39
CX.33775/3	TRW. 22.150.775	Rep. CX. 11.140 a 14.170 (TAS-65) sem junta			39
CX.33805	ZF. 8090.298.805	Rep. CX. Servocom Completo 8090.298.805			54
CX.33810	ZF. 8097.298.810	Rep. CX. Servocom - 16.170 a 40.430 (Tampas de Borracha) Rep. CX. Constellation 17.260 a 31.360 (Tampas de Borracha)			38
CX.33927	REP. CX. JTEKT / KOYO	Gol G5 com coifa	X	X	54
CX.33927/2	REP. CX. JTEKT / KOYO	Gol G5 sem coifa		X	54
CX.33928	KOYO - 7750000013	Rep. CX. Fox / Polo (Após 03) / Gol após 09 GV	X	X	44
CX.33928/2	KOYO - 7750000013	Rep. CX. Fox / Polo (Após 03) / Gol após 09 GV		X	44
CX.33953	ZF. 7891.633.501	Rep. CX. Bora 98... / Golf 99 ... / New Beetle 98...	X	X	33
CX.33953/2	ZF. 7891.633.501	Rep. CX. Bora 98... / Golf 99 ... / New Beetle 98...		X	33
CX.33954/2	KOYO / SMI	Rep. CX. Passat / Variant (Alemão) após 99			47
CX.33956	ZF. CORDOBA IBIZA	Rep. CX. ZF. Cordoba Ibiza até 99 com coifa	X		54
CX.33956/2	ZF. CORDOBA IBIZA	Rep. CX. ZF. Cordoba Ibiza até 99			54
CX.33957	ZF. 7691.633.506	Rep. CX. Golf 2010... com coifas (bucha sem retentor)	X	X	54
CX.33957/2	ZF. 7691.633.506	Rep. CX. Golf 2010... sem coifas (bucha sem retentor)		X	54
CX.33958	ZF. 7853.974.562	Rep. CX. Amarok 2008... 2H1 422 055 C	X	X	54
CX.33958/2	ZF. 7853.974.562	Rep. CX. Amarok 2008... 2H1 422 055 C		X	54

Volvo (+)

Cód. AGEL	Ref. Mercado	Aplicação	Coifas	Buchas	Página
CX.22018	ZF. 7673.698.018	Rep. BBA. B58 / N10 / N12			44
CX.22019	ZF. 8695.633.003	Rep. BBA. Volvo FH400/420/440/FM 8x4 (Cód.BBA. 8694.974.514/521)			54
CX.22104	LUK. 543.0035.10	Rep. BBA. LUK FH12			43
CX.22801	ZF. 7683.298.801	Rep. BBA. F12 / NH12 / FM12			37
CX.33017	ZF. 8065.698.017	Rep. CX. B58			37

Cód. AGEL	Ref. Mercado	Aplicação	Coifas	Buchas	Página
CX.33043/2	TRW	Rep. CX. Volvo 240 (79 a 88) / 260 (79 a 88) / 340 (75 a 91) / 960 (91 a 97) Rep. CX. 360 (75 a 91) / 440 (86 a 96) / 460 (86 a 96) / 480 (86 a 96) Rep. CX. 740 (82 a 92) / 760 (82 a 92) / 850 (91 a 96) / 940 (91 a 94) Rep. CX. S70 após 97 / S90 após 98 / V70 após 97 / V90 após 97			44
CX.33057	ZF. 8043.698.057	Rep. CX. Volvo N10 / N12 / B10 M			44
CX.33058/2	SMI / KOYO	Rep. CX. Volvo S70 / V70 (98 a 00) / 850 (93 a 97)			54
CX.33226	ZF. 8097.698.226	Rep. CX. Servocom - B10M / B12B / NL10 / NL12 (Tampas de Plástico)			37
CX.33810	ZF. 8097.298.810	Rep. CX. Servocom (Todos 8097) Tampas de Borracha			38
CX.33811	ZF. 8098.298.800	Rep. CX. FM12 / FH12 / NH12 / FH400 / FM420 / FH440			40

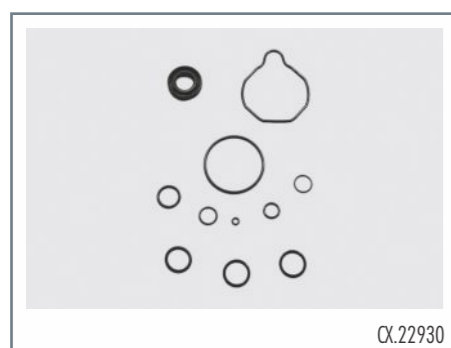

CX.22930

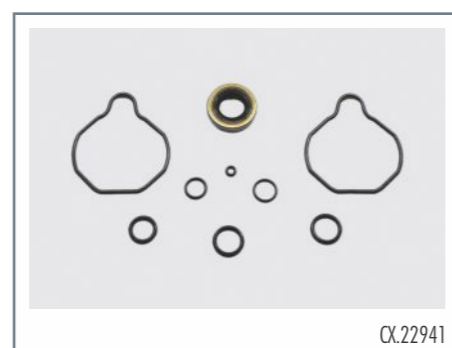

CX.22941



CX.33246/2



CX.22700



CX.33010 e CX.33010/2 (sem coifas)



CX.33014/2

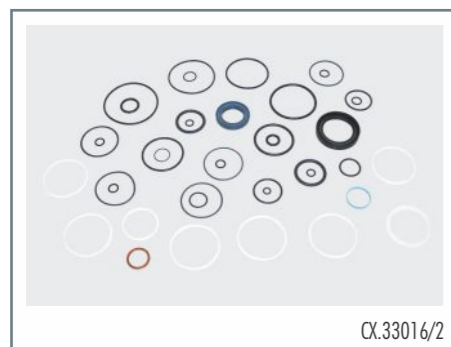

CX.33016/2

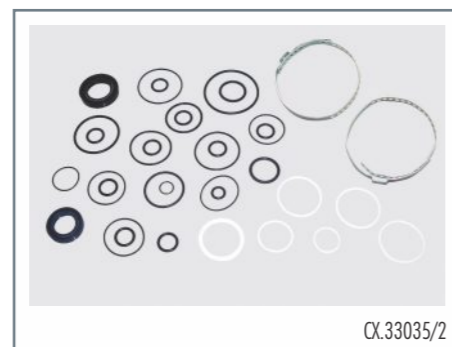

CX.33035/2



CX.33096



CX.33953 e CX.33953/2 (sem coifas)

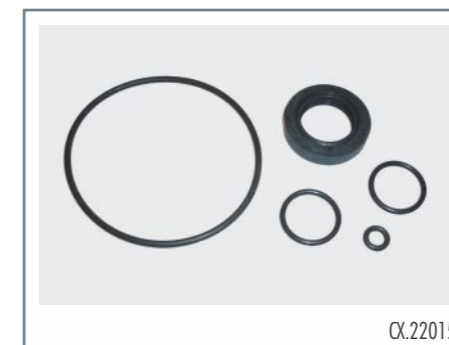

CX.22015



CX.22958



CX.33008/2



CX.33009/2



CX.33011 e CX.33011/2



CX.33025/2

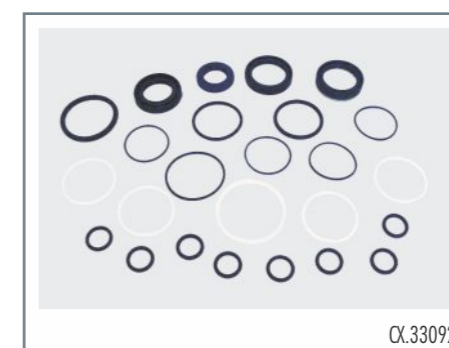

CX.33092



CX.33094/2

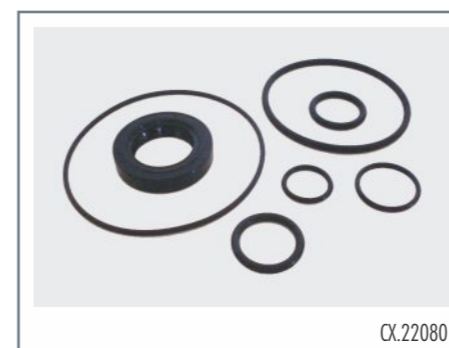

CX.22080

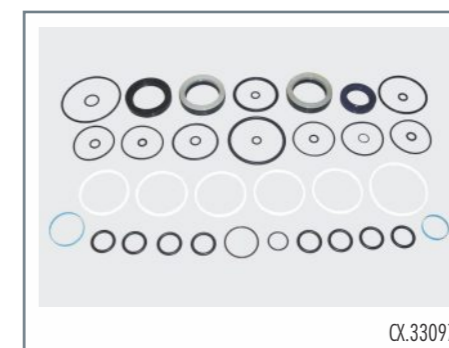

CX.33097



CX.22003



CX.22028



CX.22022



CX.22023

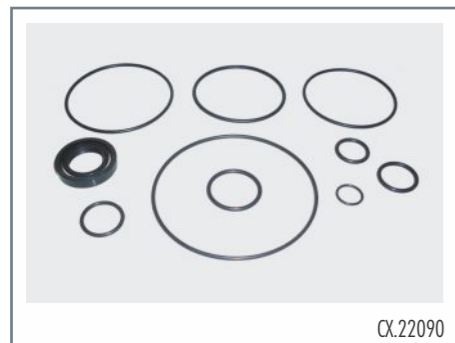

CX.22090

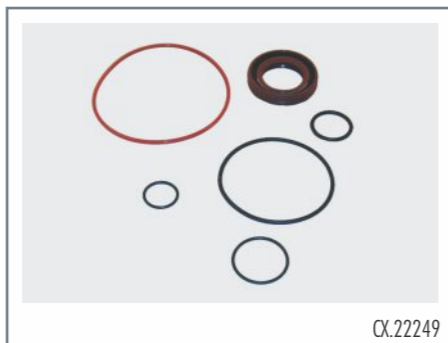

CX.22249

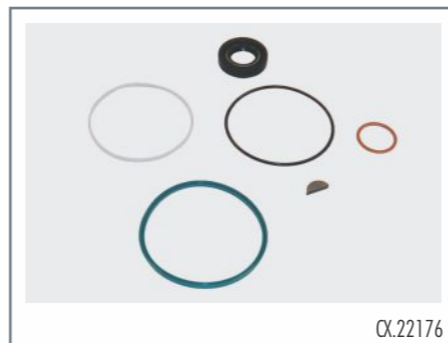

CX.22176



CX.22107



CX.22103

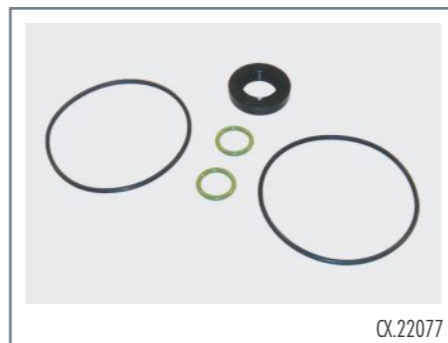

CX.22077

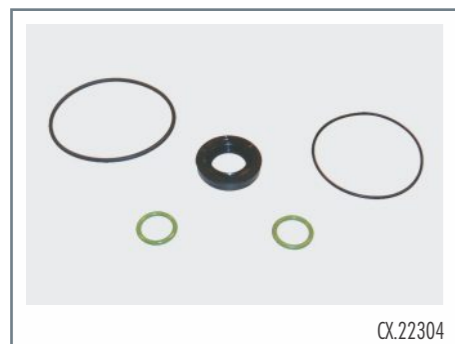

CX.22304

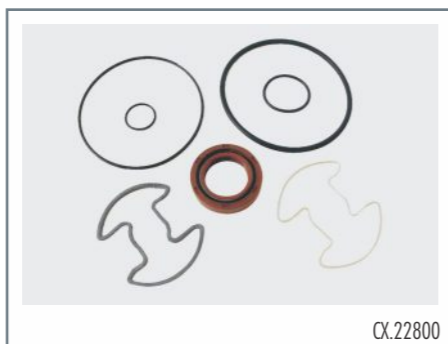

CX.22800



CX.33012 e CX.33012/2 (sem coifas)



CX.33013/2



CX.33122



CX.33169 e CX.33169/2 (sem coifas)



CX.33827 e CX.33827/2 (sem coifas)



CX.33031



CX.33049 e CX.33049/2 (sem coifas)



CX.33070 e CX.33070/2 (sem coifas)



CX.33071 e CX.33071/2 (sem coifas)



CX.33143 e CX.33143/2 (sem coifas)



CX.33062/2



CX.33100 e CX.33100/2 (sem coifas)



CX.33112 e CX.33112/2 (sem coifas)

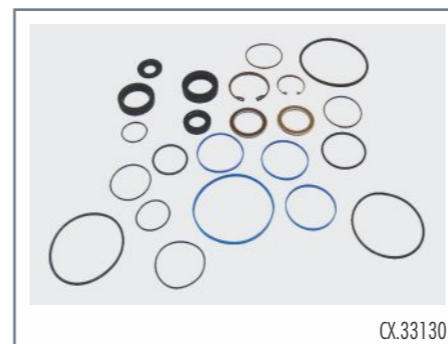

CX.33130



CX.33210



CX.33251



CX.33015

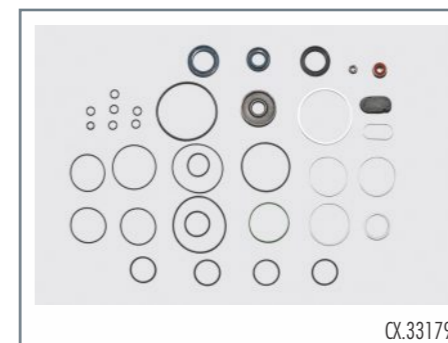

CX.33179



CX.33235



CX.33101



CX.33107 e CX.33107/2 (sem coifas)

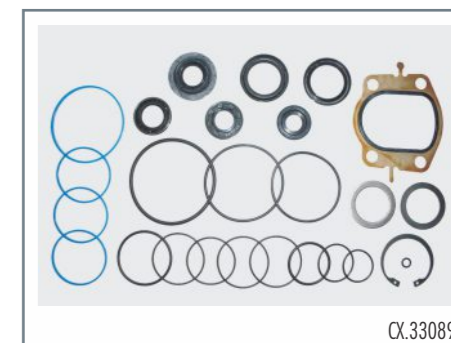

CX.33089

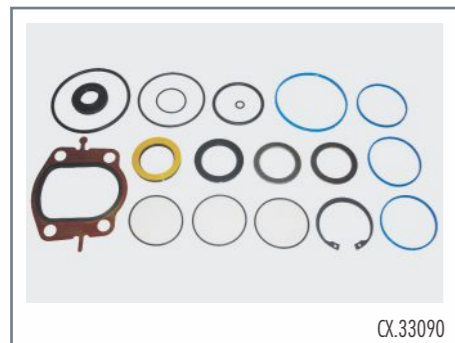

CX.33090



CX.33108



CX.22054



CX.33111 e CX.33111/2 (sem coifas)



CX.33758 e CX.33758/2 (sem coifas)



CX.33760 e CX.33760/2 (sem coifas)



CX.33147/2



CX.22802



CX.33150



CX.33844 e CX.33844/2 (sem coifas)



CX.33940 e CX.33940/2 (sem coifas)



CX.33736 e CX.33736/2 (sem coifas)



CX.33153



CX.33156 e CX.33156/2 (sem coifas)



CX.22101



CX.33017



CX.33199 e CX.33199/2 (sem coifas)



CX.22029

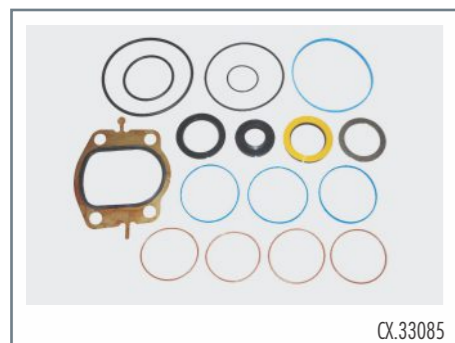

CX.33085

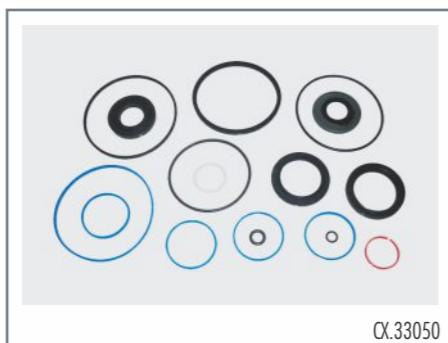

CX.33050



CX.33149/2

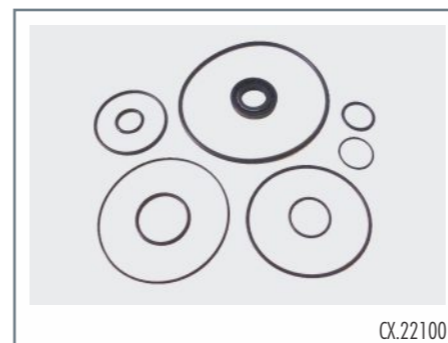

CX.22100



CX.22207

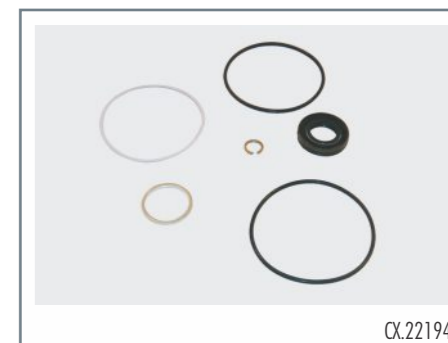

CX.22194



CX.33849 e CX.33849/2 (sem coifas)



CX.33109 e CX.33109/2 (sem coifas)



CX.33110 e CX.33110/2 (sem coifas)



CX.22801



CX.33186



CX.33226



CX.33810

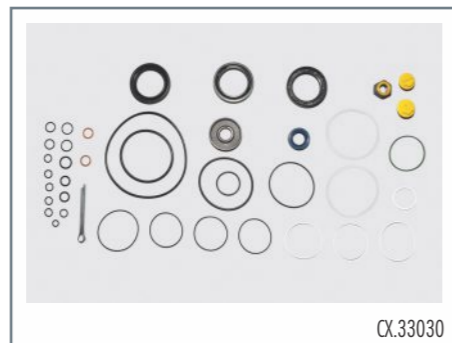

CX.33030



CX.33060

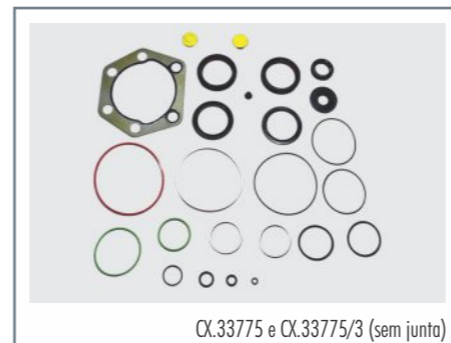

CX.33775 e CX.33775/3 (sem junta)



CX.33750 e CX.33750/2 (sem coifas)



CX.33764



CX.33095



CX.33151/2



CX.33165 e CX.33165/2 (sem coifas)



CX.33119 e CX.33119/2 (sem coifas)



CX.33200 e CX.33200/2 (sem coifas)



CX.33220/2



CX.33230



CX.33231



CX.33055



CX.33221/2



CX.33102



CX.33103 e CX.33103/2 (sem coifas)



CX.33075 e CX.33075/2 (sem coifas)



CX.33238 e CX.33238/2 (sem coifas)



CX.33218



CX.33121 e CX.33121/2 (sem coifas)



CX.33104 e CX.33104/2 (sem coifas)



CX.33914 e CX.33914/2 (sem coifas)



CX.33206 e CX.33206/2 (sem coifas)



CX.33754 e CX.33754/2 (sem coifas)



CX.33771



CX.33924



CX.33850 e CX.33850/2 (sem coifas)



CX.22300

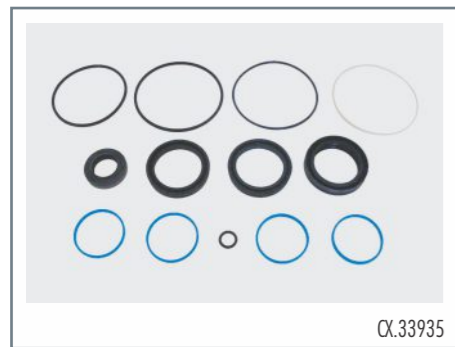

CX.33935



CX.33811



CX.33146



CX.33080



CX.33081



CX.33082/2



CX.33072 e CX.33072/2 (sem coifas)

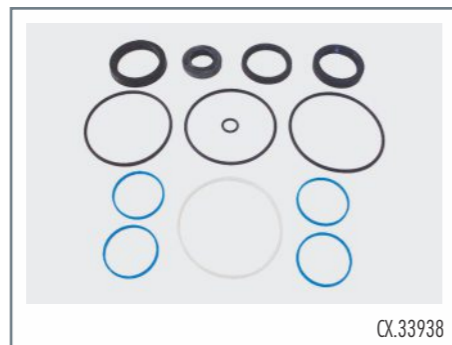

CX.33938



CX.33905



CX.33083/2



CX.33610 e CX.33610/2 (sem coifas)



CX.33611 e CX.33611/2 (sem coifas)



CX.33182/2



CX.33183 e CX.33183/2 (sem coifas)



CX.22105



CX.33612 e CX.33612/2 (sem coifas)

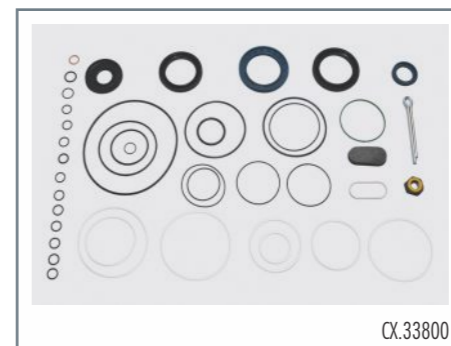

CX.33800



CX.33900



CX.22030



CX.22002



CX.22263



CX.33180

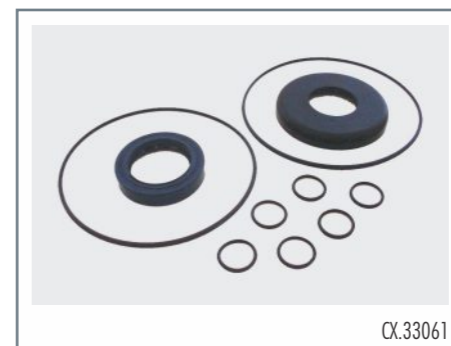

CX.33061



CX.33007

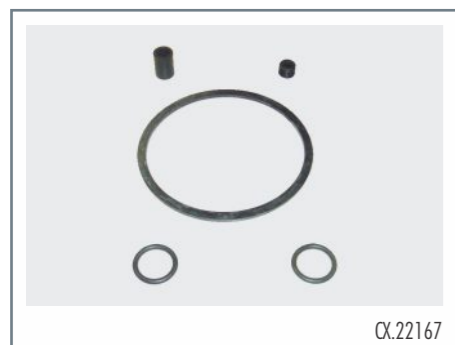

CX.22167



CX.22811

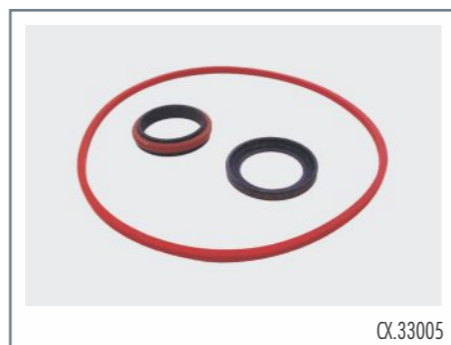

CX.33005



CX.33170



CX.33002



CX.33261

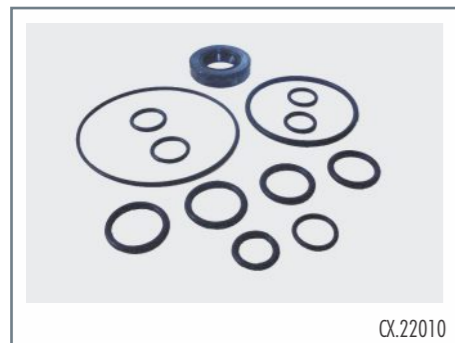

CX.22010

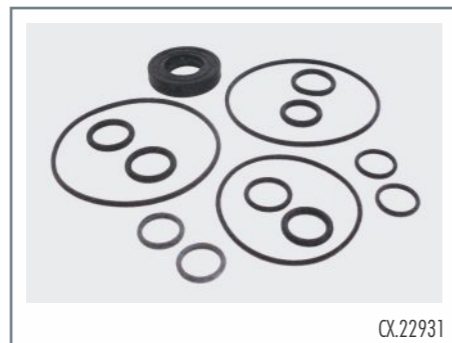

CX.22931



CX.33160/2



CX.33126 e CX.33126/2 (sem coifas)



CX.33137 e CX.33137/2 (sem coifas)



CX.33140 e CX.33140/2 (sem coifas)



CX.33931

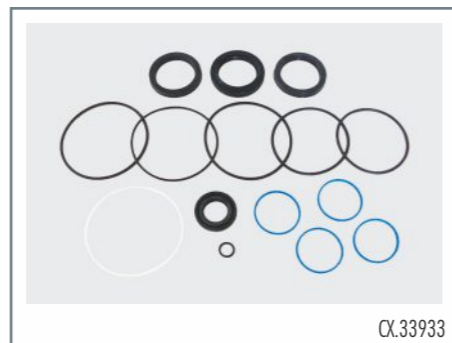

CX.33933



CX.33117 e CX.33117/2 (sem coifas)



CX.22034



CX.22035



CX.22104



CX.33926/2



CX.33929

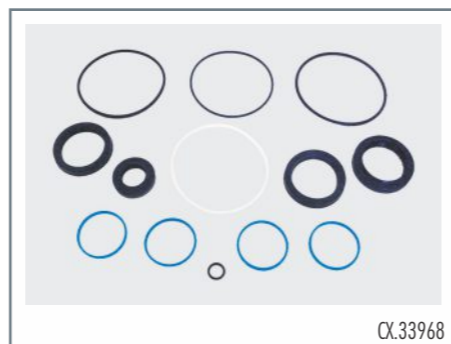

CX.33968



CX.33943 e CX.33943/2



CX.33068

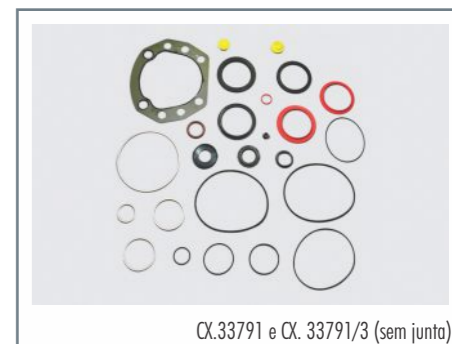

CX.33791 e CX.33791/3 (sem junta)



CX.33115 e CX.33115/2 (sem coifas)



CX.33120



CX.33172 e CX.33172/2 (sem coifas)

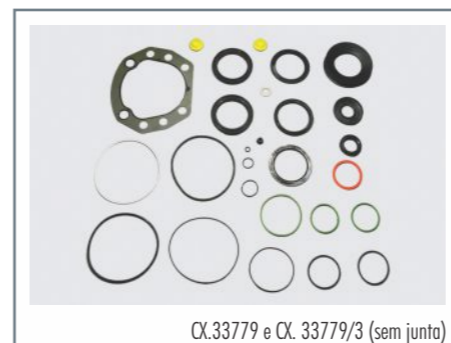

CX.33779 e CX.33779/3 (sem junta)



CX.33106 e CX.33106/2 (sem coifas)



CX.33044 e CX.33044/2 (sem coifas)



CX.33175/2



CX.33118 e CX.33118/2 (sem coifas)



CX.33125 e CX.33125/2 (sem coifas)

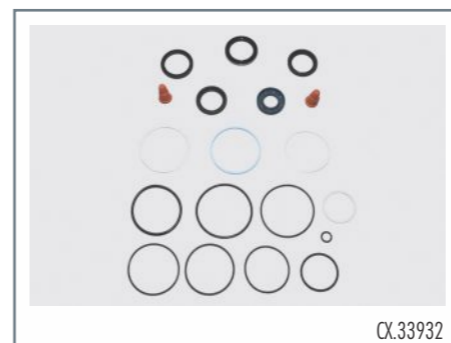

CX.33932



CX.22600

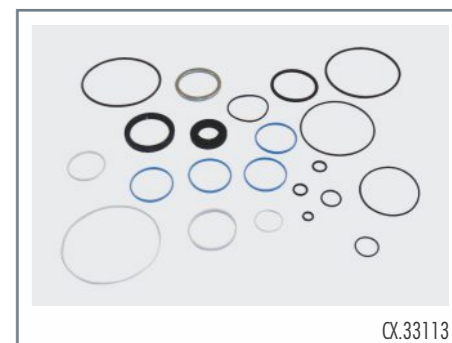

CX.33113

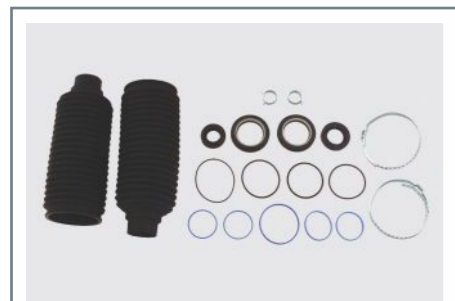

CX.33114 e CX.33114/2 (sem coifas)

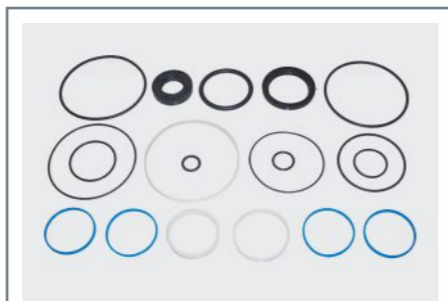

CX.33215



CX.22044



CX.33144/2

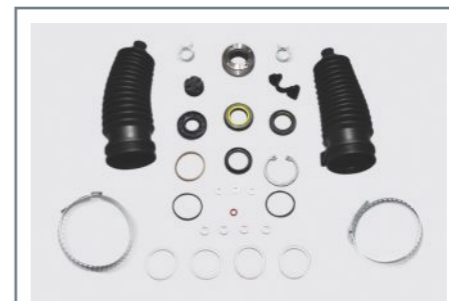

CX.33222 e CX.33222/2 (sem coifas)



CX.33279/2



CX.22208



CX.33195/2



CX.33225 e CX.33225/2 (sem coifas)



CX.33915 e CX.33915/2 (sem coifas)



CX.33504 e CX.33504/2 (sem coifas)



CX.33512 e CX.33512/2 (sem coifas)



CX.33020/2



CX.33033 e CX.33033/2 (sem coifas)



CX.33105 e CX.33105/2 (sem coifas)

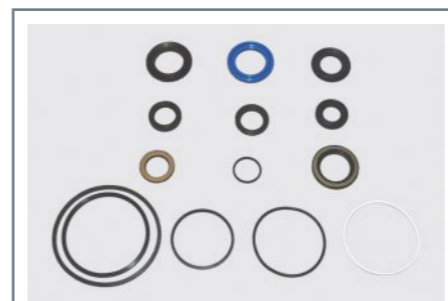

CX.33904



CX.33142/2

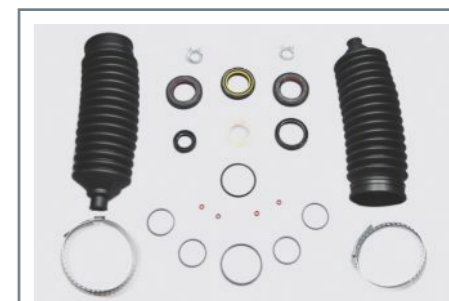

CX.33214 e CX.33214/2 (sem coifas)



CX.33752 e CX.33752/2 (sem coifas)



CX.33928 e CX.33928/2 (sem coifas)



CX.22018

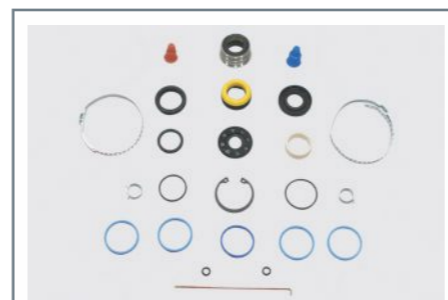

CX.33166 e CX.33166/2 (sem coifas)



CX.33167 e CX.33167/2 (sem coifas)



CX.33168 e CX.33168/2 (sem coifas)



CX.33043/2



CX.33057



CX.33152



CX.33503 e CX.33503/2 (sem coifas)



CX.33163 e CX.33163/2 (sem coifas)



CX.33173 e CX.33173/2 (sem coifas)

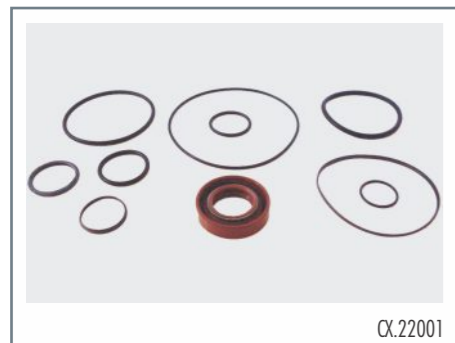

CX.22001



CX.33255



CX.22005



CX.33099



CX.33954/2

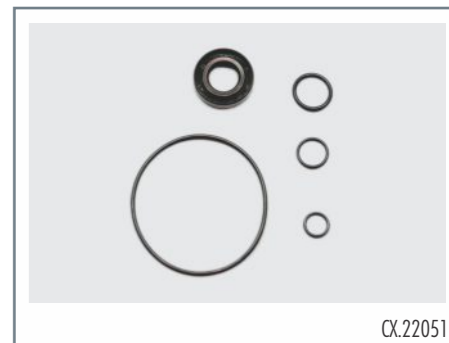

CX.22051



CX.33040 e CX.33040/2 (sem coifas)



CX.33042 e CX.33042/2 (sem coifas)



CX.33751/2

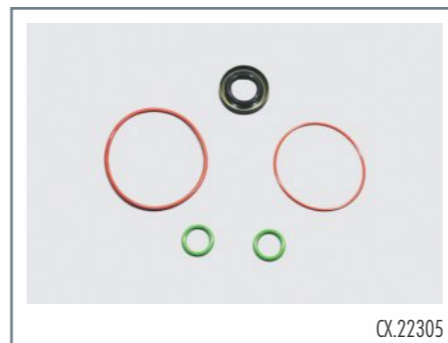

CX.22305

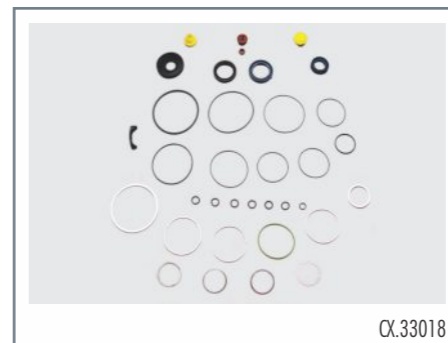

CX.33018

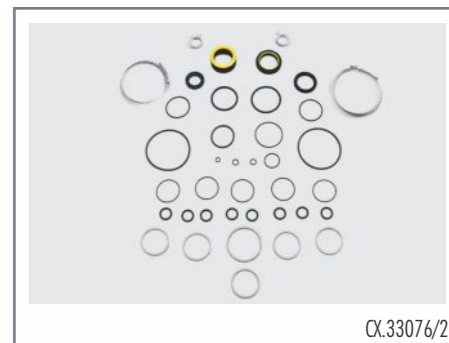

CX.33076/2



CX.33019



CX.33116 e CX.33116/2 (sem coifas)

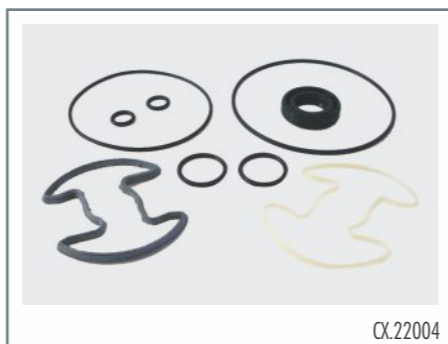

CX.22004



CX.33077/2

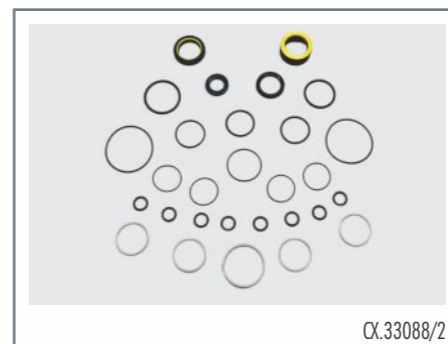

CX.33088/2

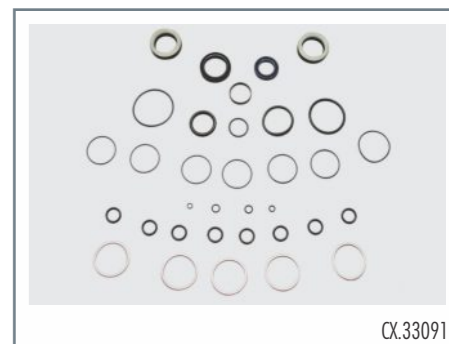

CX.33091

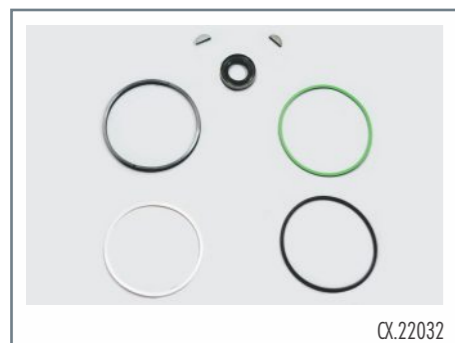

CX.22032



CX.33006



CX.33078/2

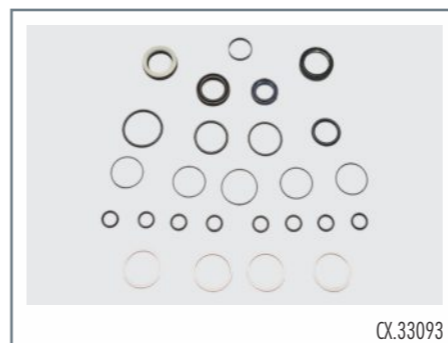

CX.33093



CX.33127 e CX.33127/2 (sem coifas)

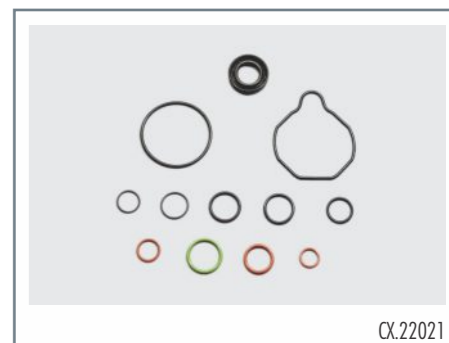

CX.22021



CX.33086/2

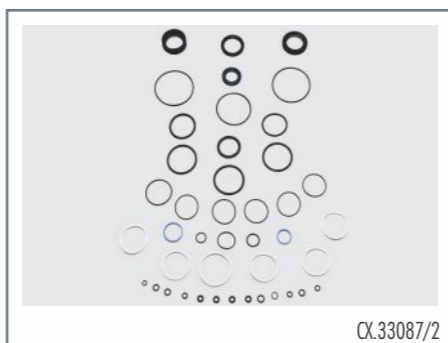

CX.33087/2



CX.33098

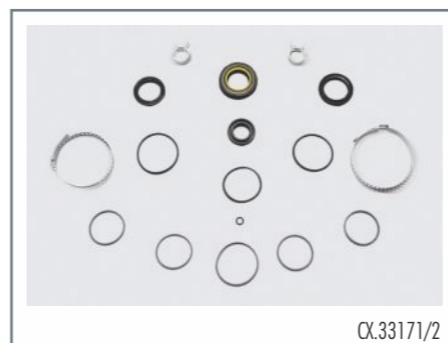

CX.33171/2



CX.33252/2



CX.33828 e CX.33828/2 (sem coifas)



CX.22932



CX.33145/2



CX.33148/2



CX.33917 e CX.33917/2 (sem coifas)



CX.33318 e CX.33318/2

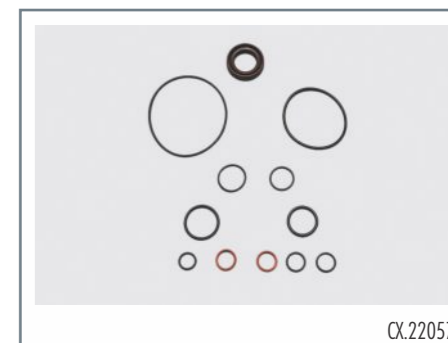

CX.22057



CX.33247/2 (sem coifas)

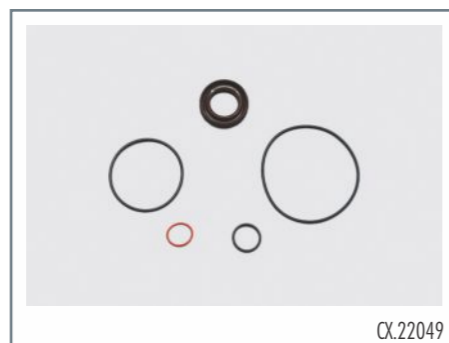

CX.22049

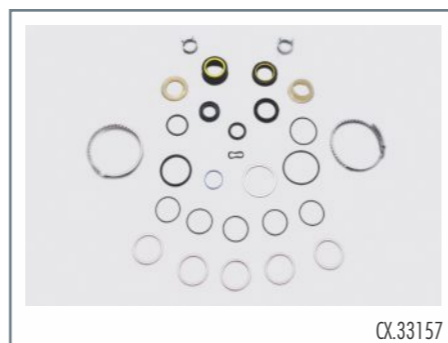

CX.33157

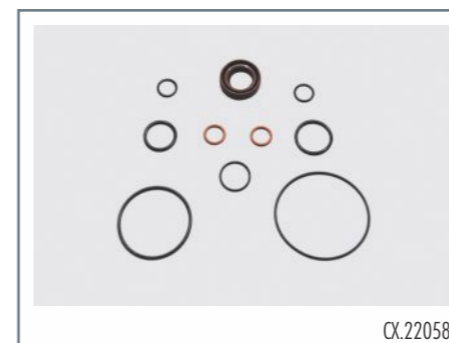

CX.22058



CX.33834/2



CX.33835/2



CX.22602



CX.33845 e CX.33845/2 (sem coifas)



CX.33847 e CX.33847/2 (sem coifas)



CX.33851 e CX.33851/2 (sem coifas)



CX.33852/2



CX.33853/2

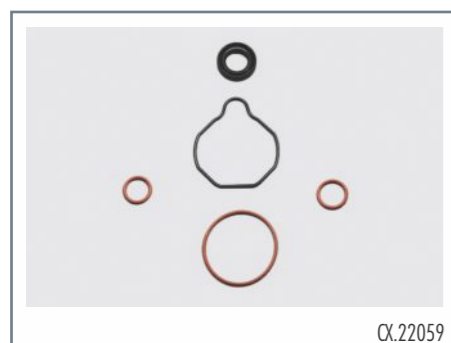

CX.22059



CX.33223 e CX.33223/2 (sem coifas)

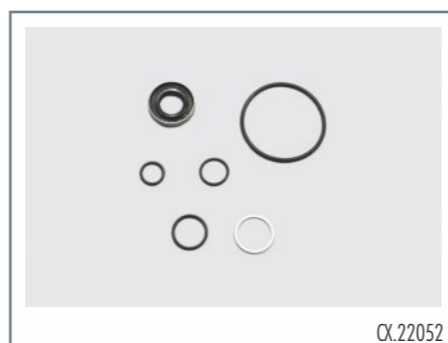

CX.22052

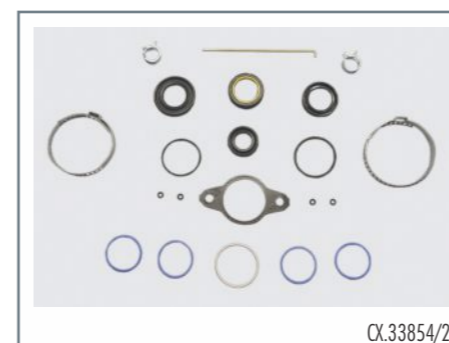

CX.33854/2

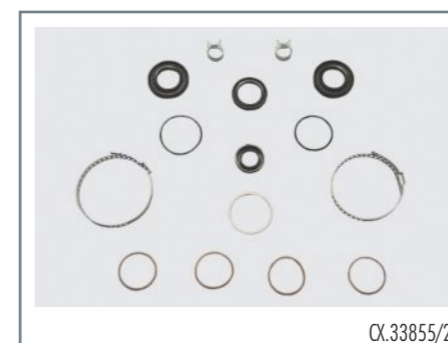

CX.33855/2



CX.33856 e CX.33856/2 (sem coifas)



CX.33164 e CX.33164/2 (sem coifas)



CX.33907 e CX.33907/2 (sem coifas)



CX.33916 e CX.33916/2 (sem coifas)



CX.33857 e CX.33857/2 (sem coifas)

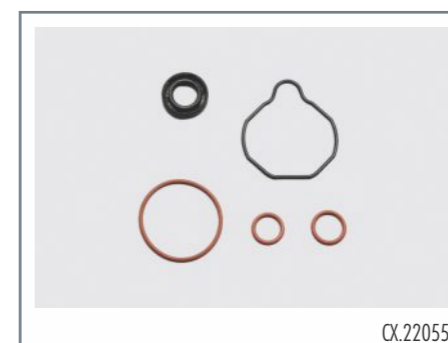

CX.22055

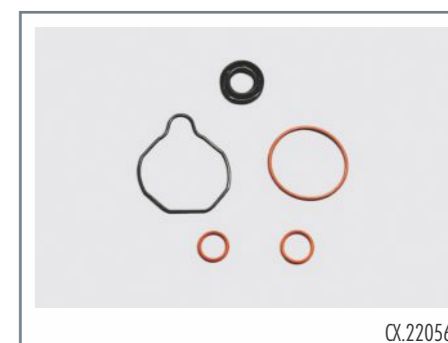

CX.22056

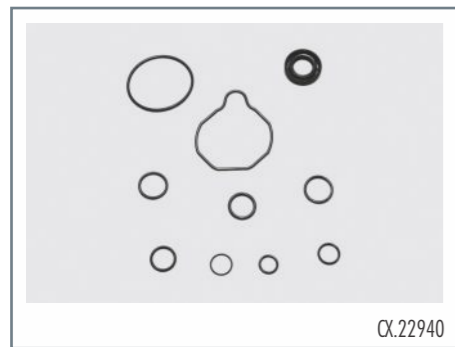

CX.22940

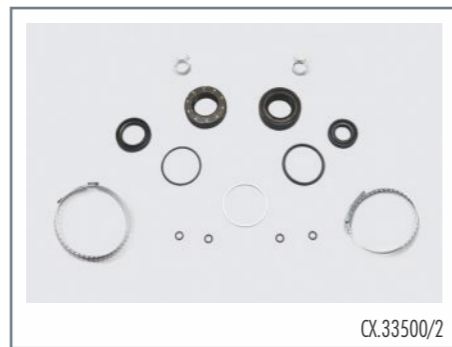

CX.33500/2

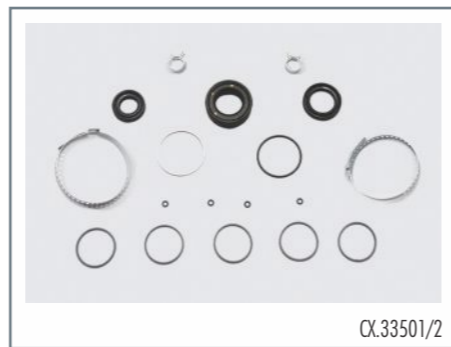

CX.33501/2



CX.33052

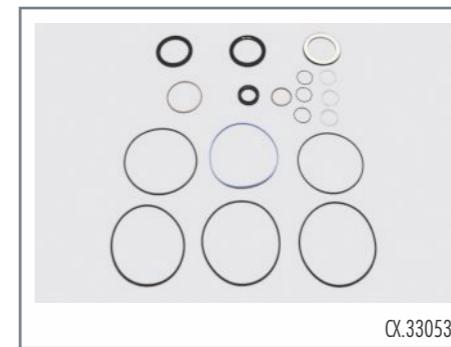

CX.33053

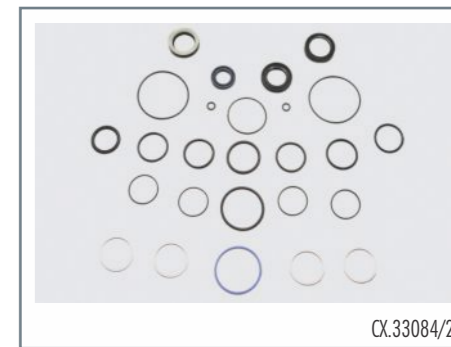

CX.33084/2



CX.33502 e CX.33502/2 (sem coifas)



CX.33506/2



CX.33507/2



CX.33865 e CX.33865/2 (sem coifas)

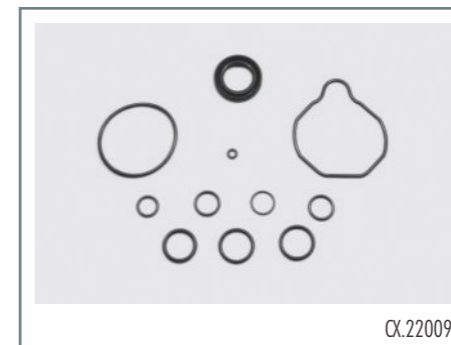

CX.22009

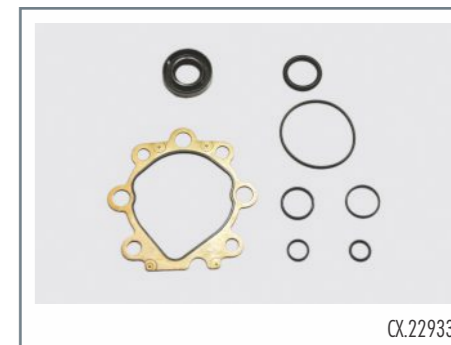

CX.22933



CX.33508/2



CX.33510/2



CX.33511/2



CX.33128/2

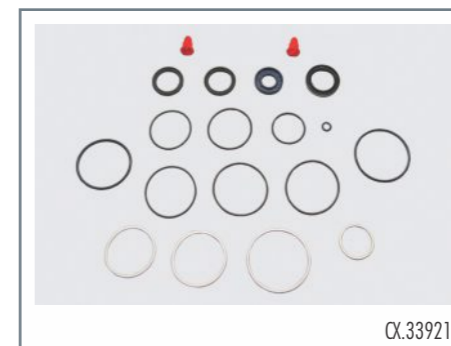

CX.33921



CX.33930/2



CX.33513 e CX.33513/2 (sem coifas)

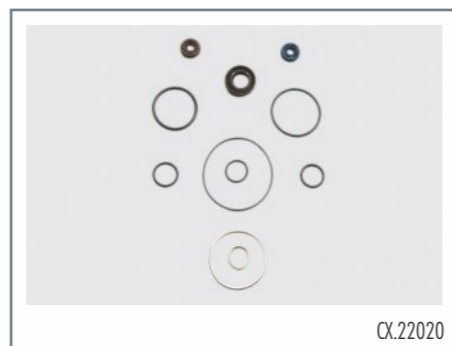

CX.22020

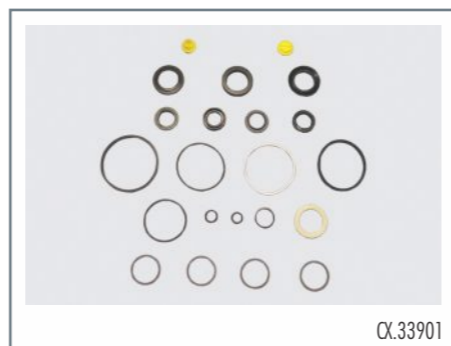

CX.33901



CX.33934 e CX.33934/2 (sem coifas)



CX.33936/2



CX.33937 e CX.33937/2 (sem coifas)



CX.33902

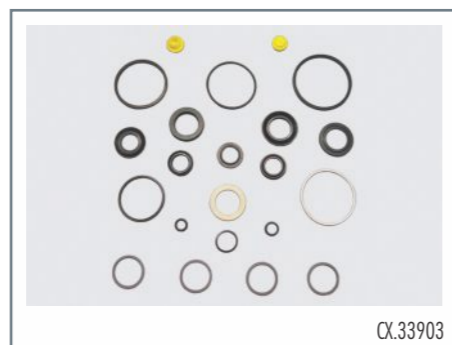

CX.33903



CX.33241 e CX.33241/2 (sem coifas)



CX.33939/2



CX.33941/2



CX.33942/2

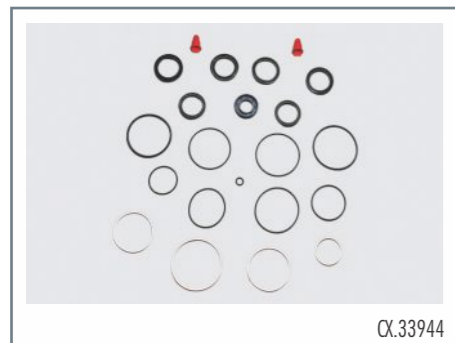

CX.33944



CX.33945 e CX.33945/2 (sem coifas)

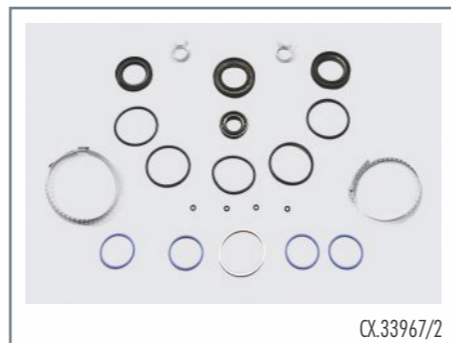

CX.33967/2

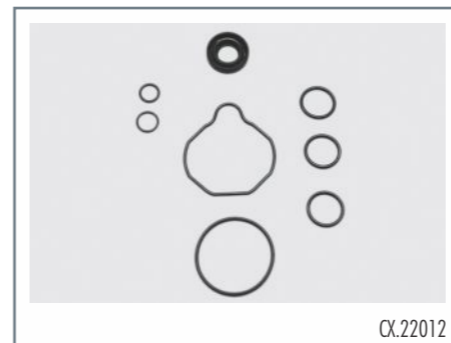

CX.22012

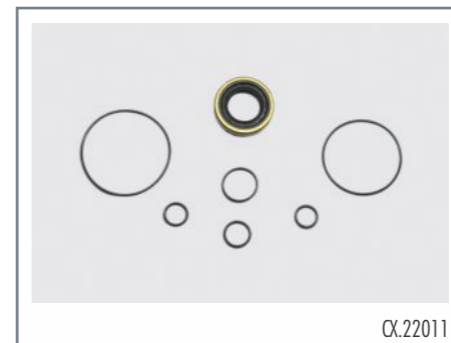

CX.22011

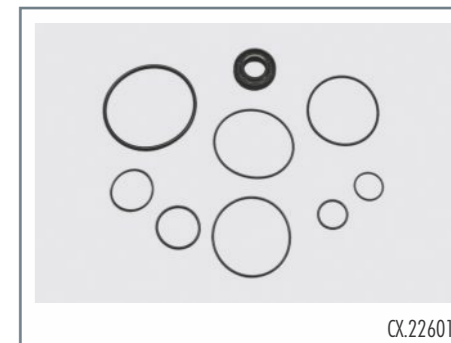

CX.22601

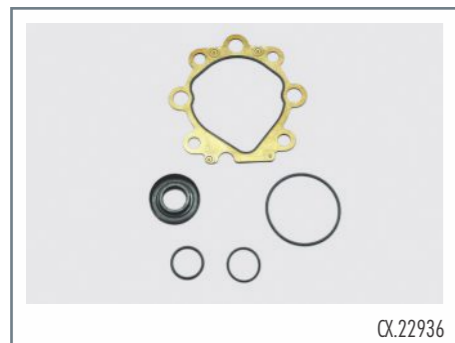

CX.22936



CX.33123 e CX. 33123/2 (sem coifas)



CX.33124 e CX. 33124/2 (sem coifas)

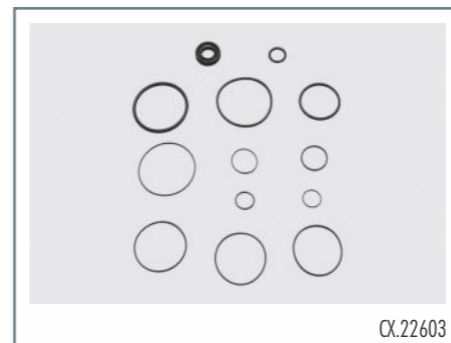

CX.22603

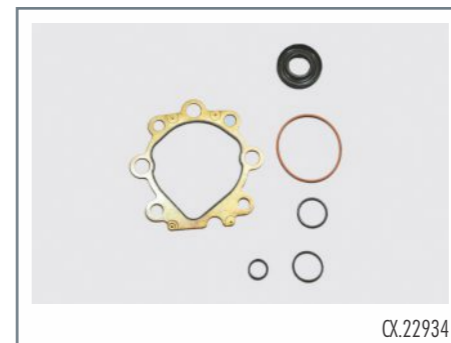

CX.22934

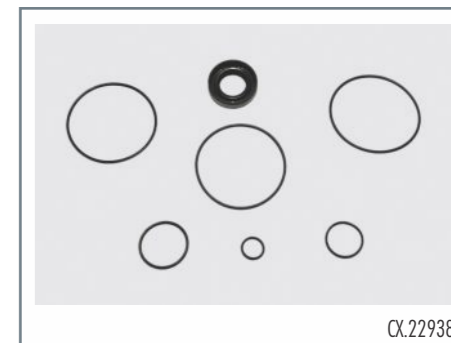

CX.22938



CX.33176 e CX. 33176/2 (sem coifas)



CX.33846 e CX. 33846/2 (sem coifas)



CX.33067



CX.33232 e CX.33232/2 (sem coifas)



CX.33236 e CX.33236/2 (sem coifas)



CX.33237 e CX.33237/2 (sem coifas)



CX.33141 e CX.33141/2 (sem coifas)



CX.33045/2



CX.33046/2



CX.33239 e CX.33239/2 (sem coifas)



CX.33240/2



CX.33242/2



CX.33047/2



CX.33048/2



CX.33059/2



CX.33243/2



CX.33244/2



CX.33245/2

Problemas X Causas

A análise de problemas e causas apresentadas na próxima página servem apenas como referência para determinadas análises. Apresentam um pouco da experiência de nossa equipe com o sistema de direção referente a determinadas falhas. Desta forma, a tabela passa a ser uma ferramenta "viva" e deve sofrer revisões sempre que necessário, para o que contamos com a sua contribuição.



Tabela para Ajustes de Eixos e Furos



TOLERÂNCIA ISO (ABNT) PARA AJUSTE DE EIXO

Ø mm	D8	D9	D10	E6	E7	E8
10 - 18	-0,050 -0,077	-0,050 -0,093	-0,050 -0,120	-0,032 -0,043	-0,032 -0,050	-0,032 -0,059
18 - 30	-0,065 -0,098	-0,065 -0,117	-0,065 -0,149	-0,040 -0,053	-0,040 -0,061	-0,040 -0,073
30 - 50	-0,080 -0,119	-0,080 -0,142	-0,080 -0,180	-0,050 -0,068	-0,050 -0,075	-0,050 -0,089

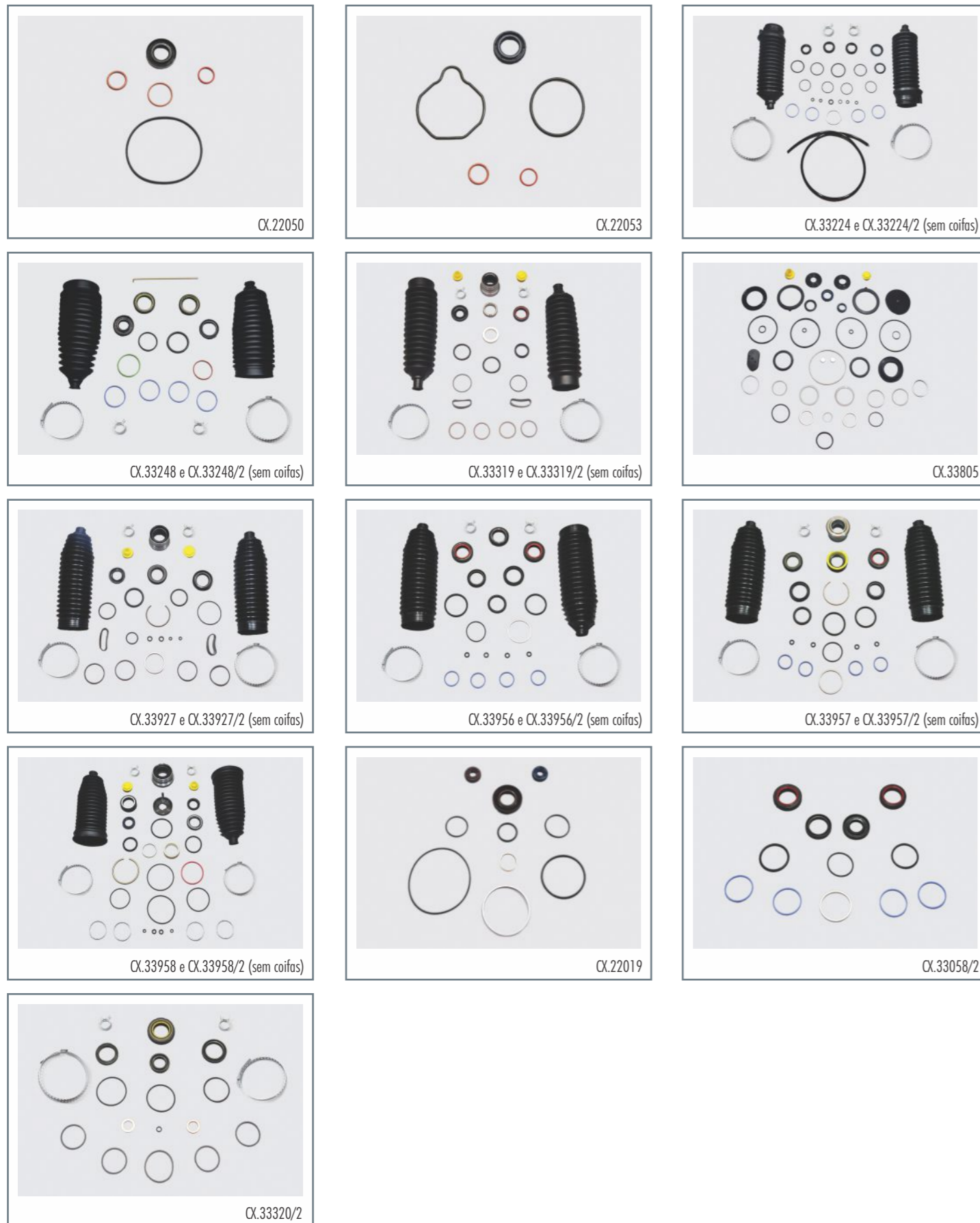
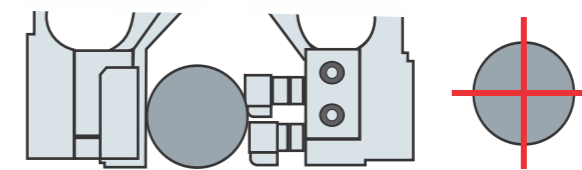
*Tabela e tolerância de acordo com as normas da ABNT

APC

A MARCA DA QUALIDADE

Quem entende de vedação, aprova APC kits e reparos.
Produzidos em nosso parque industrial com tecnologia de ponta,
garantem segurança e bem estar para o usuário,
variedade e qualidade de atendimento e pronta entrega
para o revendedor e praticidade para o montador.

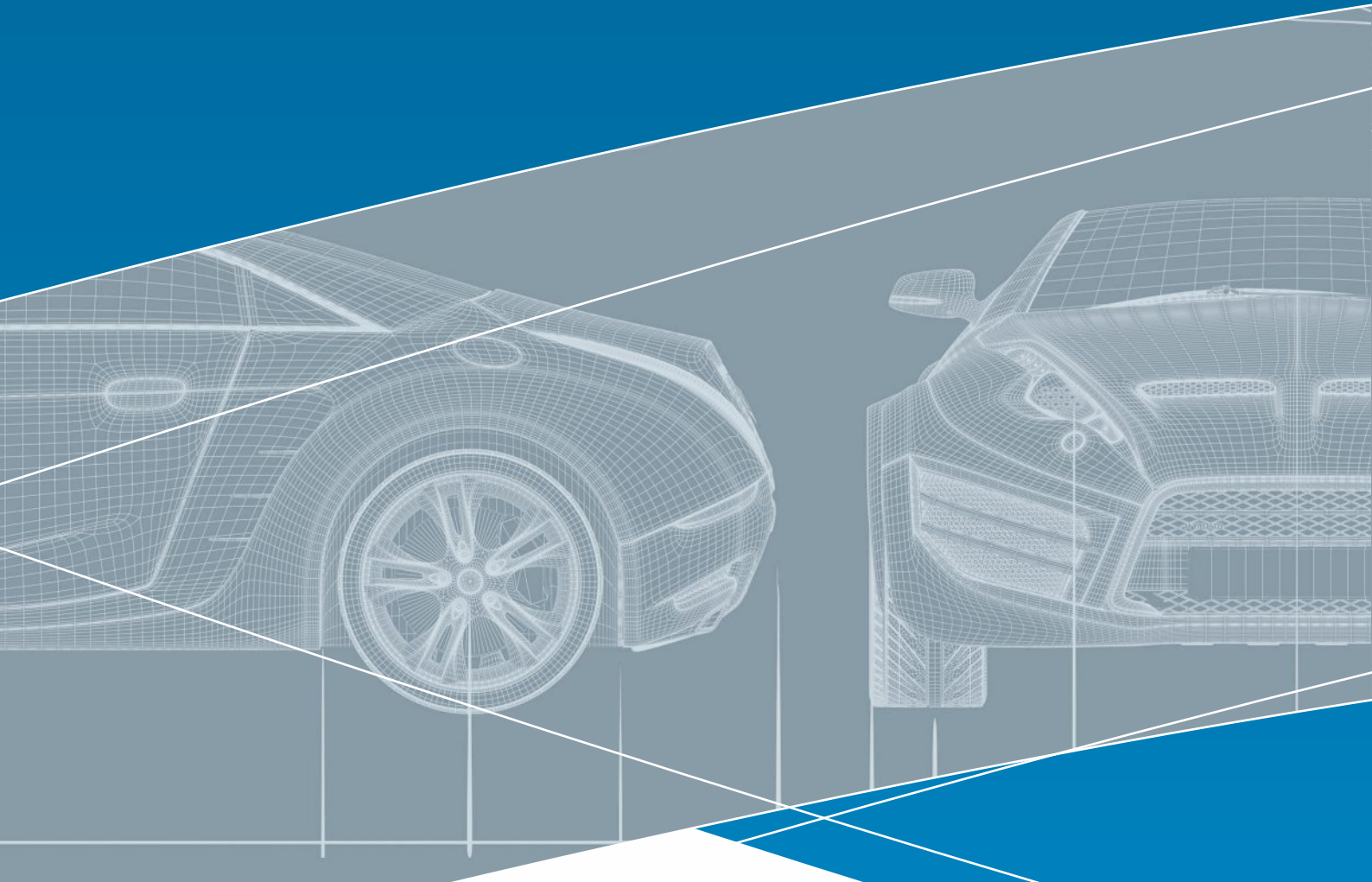

Conteúdo Aprovado | Distribuidor Autorizado

A P C

A MARCA DA QUALIDADE



17 3302.9000

riopretovedacoes@riopretovedacoes.com.br

www.riopretovedacoes.com.br